

REVISIONS FOR DWG # 3EN-3IS-AK-AK12

REV	CH.NO.	DESCRIPTION	DATE	REVISED BY
-	-	ORIGINAL DESIGN	08/01/11	ROLAND G

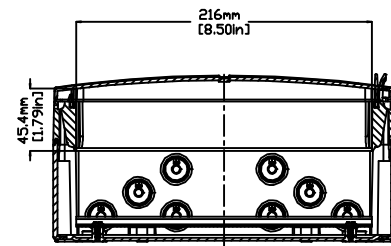

SECTION B-B

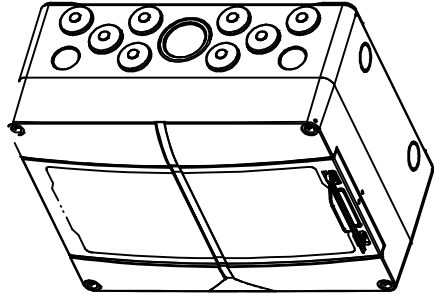
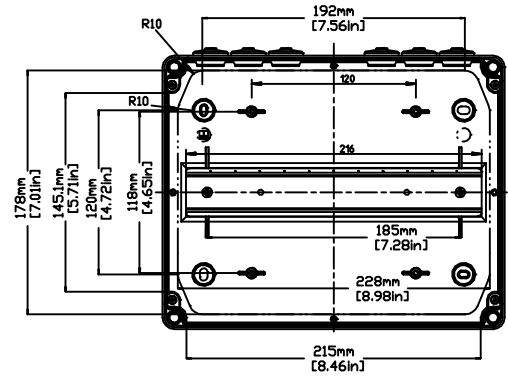
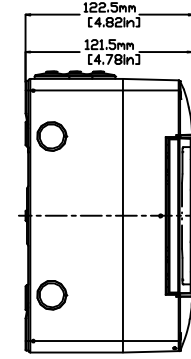

INTERIOR VIEW WITHOUT LID

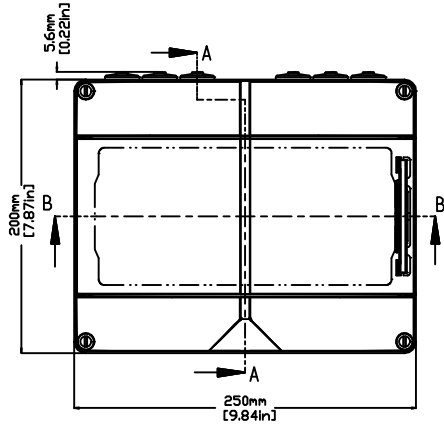

SECTION A-A

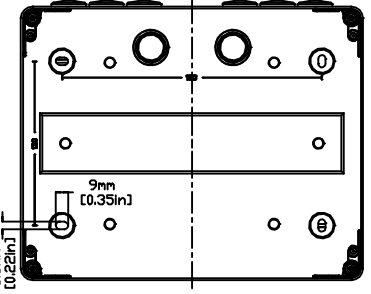
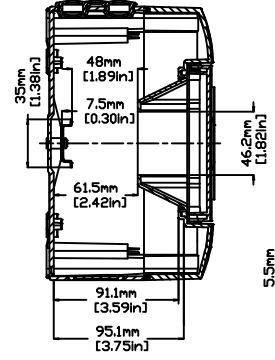

BOTTOM VIEW

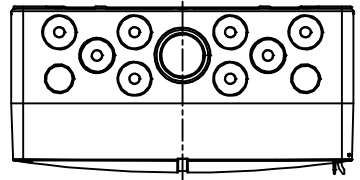

UNLESS OTHERWISE SPECIFIED
 • ALL DIMENSIONS ARE IN MILLIMETERS
 • THIRD ANGLE PROJECTION

• TOLERANCE	
XX	± XX mm
XX.X	± XX mm
XX.XX	± XX mm
ALL	± XX mm

This Drawing is the property of
Altrech Corp.
 35 Royal Road
 Flemington NJ 08822-6000
 (908) 806-9400 • Fax (908) 806-9490

AND IS A CONFIDENTIAL DISCLOSURE
 LENT WITHOUT CONSIDERATION OTHER
 THAN THE BORROWER'S AGREEMENT
 THAT IT SHALL NOT BE REPRODUCED,
 COPIED, LENT, OR DISPOSED OF
 DIRECTLY OR INDIRECTLY NOR USED
 FOR ANY PURPOSE OTHER THAN THAT
 FOR WHICH IT IS SPECIFICALLY
 FURNISHED.

TITLE: POLYSTYRENE/ POLYCARBONATE ENCLOSURE
 AK 12

DRAWN BY: ROLAND GYORGYAL	08/01/2011	DRAWING NO.:	3EN-3IS-AK-AK12	REV.:	-
CHECKED BY: JEFF ROYE	08/01/2011	SCALE:	-	SHEET:	1 OF: 1
RELEASED BY: LASZLO G.	08/01/2011				