

REVISION FOR DWG # 1PB-3-001-Q-11

REV	CH.NO.	DESCRIPTION	DATE	REVISED BY
-	-	ORIGINAL DESIGN	11/2/2007	PHILIPP E.

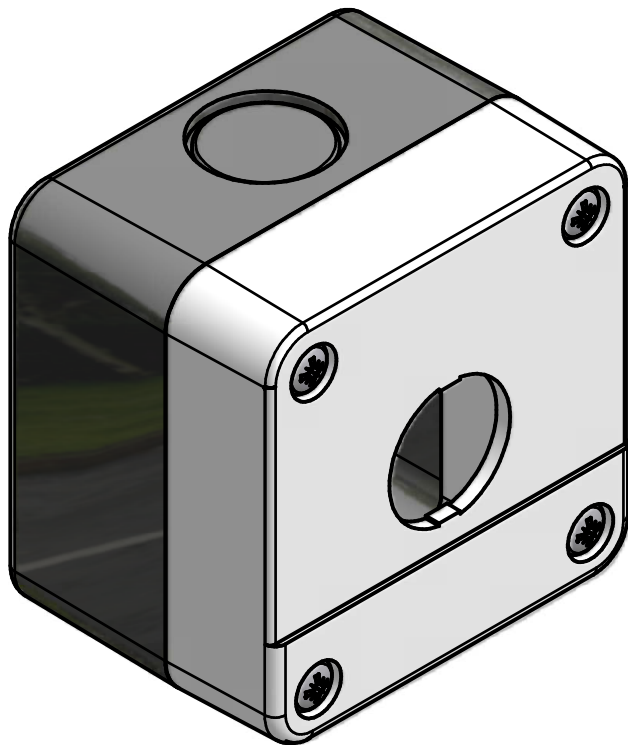

Plastic enclosure suited for non-illuminated push buttons with maximum 2 contact elements.

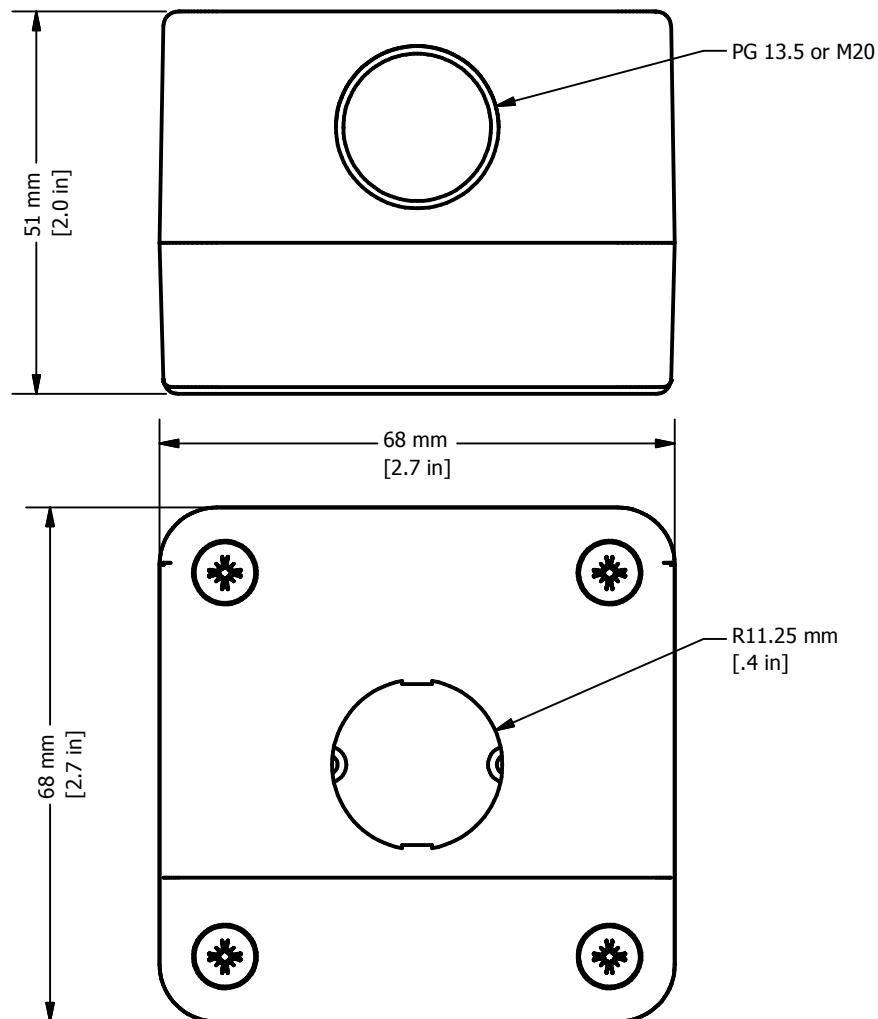

UNLESS OTHERWISE SPECIFIED:  
 • ALL DIMENSIONS ARE IN MILLIMETERS  
 • THIRD ANGLE PROJECTION



This Drawing is the property of

**Altech Corp.**

35 Royal Road  
 Flemington, NJ 08822-6000  
 (908) 806-9400  
 Fax (908) 806-9490

AND IS A CONFIDENTIAL DISCLOSURE  
 WITHOUT THE BORROWER'S AGREEMENT THAT IT SHALL NOT BE REPRODUCED, COPIED, LENT OR DISPOSED OF DIRECTLY OR INDIRECTLY NOR USED FOR ANY PURPOSE OTHER THAN THAT FOR WHICH IT IS SPECIFICALLY FURNISHED.

TITEL 22 mm Thermoplastic Enclosure White/Black Operator Capacity 1  
 3-001-Q-11

TOLERANCE		
XX	=	±1 mm
XX.X	=	±0.5 mm
XX.XX	=	±0.2 mm
ALL	=	- mm

M  
E  
T  
R  
I  
C

DRAWN BY: Philipp Ernstberger	11/2/2007	DRAWING NO.:	1PB-3-001-Q-11	REV.:	-
CHECKED BY: Laszlo Gyorgypal	11/2/2007	SCALE:	-	SHEET:	1
RELEASED BY: Laszlo Gyorgypal	11/2/2007			OF:	1