



# PSC-20 Series



## Features:

- Universal AC input (88-264V AC)
- Protections: Short Circuit / Overload / Overvoltage
- Brown-out protection
- Installed on DIN rail TS35 / 7.5 or 15
- True DC OK signal output
- All wiring 105°C long life electrolytic capacitors
- High operation temperature up to 70°C
- Withstands 2G vibration test
- High efficiency, long life and high reliability
- 3 year warranty
- UL1310 Class 2 Power unit / LPS pass
- UL508 (Industrial control equipment) listed

## OUTPUT

## INPUT

## PROTECTION

## ENVIRONMENT

## SAFETY & EMC

## OUTPUT

Cat. No.	PSC-2012	PSC-2015	PSC-2024
----------	----------	----------	----------

DC VOLTAGE	12V	15V	24V
RATED CURRENT	1.7A	1.4A	1A
CURRENT RANGE	0~1.7A	0~1.4A	0~1A
RATED POWER	20.4W	21W	24W
RIPPLE & NOISE (max)	100mVp-p	100mVp-p	120mVp-p
Ripple & noise are measured at 20MHz of bandwidth by using a 12" twisted pair-wire terminated with a 0.1µF & 47µF parallel capacitor			
VOLTAGE ADJ. RANGE	10.8~13.2V	13.5~16.5V	21.6~26.4V
VOLTAGE TOLERANCE	±1.0%	±1.0%	±1.0%
Tolerance: includes set up tolerance, line regulation and load regulation.			
LINE REGULATION	±1.0%	±1.0%	±1.0%
LOAD REGULATION	±1.0%	±1.0%	±1.0%
SETUP, RISE TIME	< 800ms, < 100ms/230V AC at full load		
HOLD UP TIME (Typ.)	> 32ms / 230V AC; > 16ms / 115V AC at full load		
VOLTAGE RANGE	88V~264VAC; 124V~370VDC		
Derating may be needed under low input voltages. Please check the derating curve for more details.			
FREQUENCY RANGE	47~63Hz		
EFFICIENCY (Typ.)	83%	85%	86%
AC CURRENT (Typ.)	0.45A/115VAC; 0.32A/230VAC		
INRUSH CURRENT (Typ.)	20A / 115V AC; 40A / 230V AC		
LEAKAGE CURRENT	< 1mA/ 230VAC		
OVERLOAD PROTECTION	> 105% rated output power		
Protection type: Constant current limiting, recovers automatically after fault condition is removed.			
OVERVOLTAGE PROTECTION	115%~150% rated output voltage		
Protection type: Latch-off mode.			
OVER TEMPERATURE PROTECTION	Power supply shut down at 70°C constant current limiting / output voltage goes to 0; re-power on to recover		
WORKING TEMP.	-20 ~ +70°C (Refer to output load derating curve)		
WORKING HUMIDITY	20 ~ 90% RH non-condensing		
STORAGE TEMP. / HUMIDITY	-40 ~ +85°C; 10 ~ 95% RH		
TEMP. COEFFICIENT	±0.03% / °C (0 ~ 50°C)		
VIBRATION	10 ~ 500Hz, 2G 10min. / 1cycle, 60 min. each long X,Y, Z axes		
SAFETY STANDARDS	UL508, TUV EN60950-1:2006+A11, UL1310 NEC class 2 compliant		
WITHSTAND VOLTAGE	I/P-O/P: 4242DC I/P-FG: 2121DC 1 minute		
ISOLATION RESISTANCE	I/P-O/P, I/P-FG, O/P-FG: 100M Ohms/500VDC		
EMI CONDUCTION & RADIATION	EN55022:2006+A1:2007 Class B		
HARMONIC CURRENT	EN61000-3-2:2006 Class A, EN61000-3-3:2008		
EMS IMMUNITY	EN61204-3:2000, EN55024:1998+A1:2001+A2:2003 light industry level, criteria A		
The power supply is considered a component which will installed into a final equipment. The final equipment must be re-confirmed that it still meets EMC directives.			
DC OK Signal	Open collector. Max: 40mA		
MTBF	120.4K HRS MIL-HDBK-217 (25°C)	131.3K HRS MIL-HDBK-217 (25°C)	125.9K HRS MIL-HDBK-217 (25°C)
DIMENSION	23x90x99 mm (WxHxD)		
PACKING	0.14Kg/48 pcs./7.92Kg		
CONNECTION	I/P 3 poles, O/P: 3 poles screw DIN terminal		
COOLING	Free air convection		
All parameters NOT specially mentioned are measured at 230V AC input, rated load and 25°C of ambient temperature.			

## Mechanical Specification

Unit : mm / inch

Terminal Pin. No Assign. (TB1)

Pin No.	Assignment
1	FG ⊕
2	AC/N
3	AC/L

Terminal Pin. No Assign. (TB2)

Pin No.	Assignment
4	DC OUTPUT +V
5	DC OUTPUT -V
6	DC OK SIGNAL

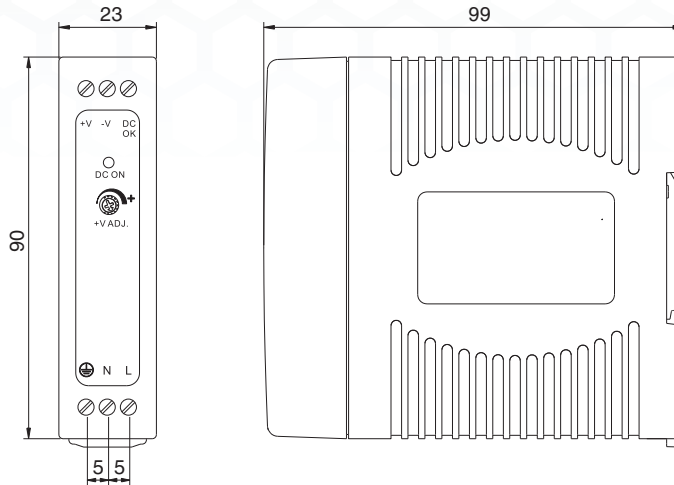

## Application of DC OK Active Signal

(a) 5V signal

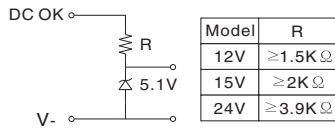

(b) LED

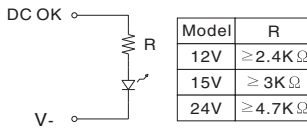

(c) Relay

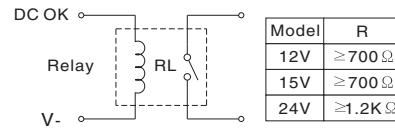

## Block Diagram

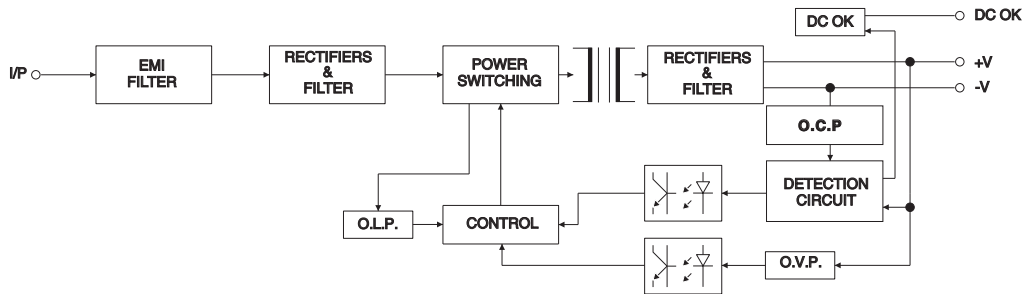

## Derating Curve

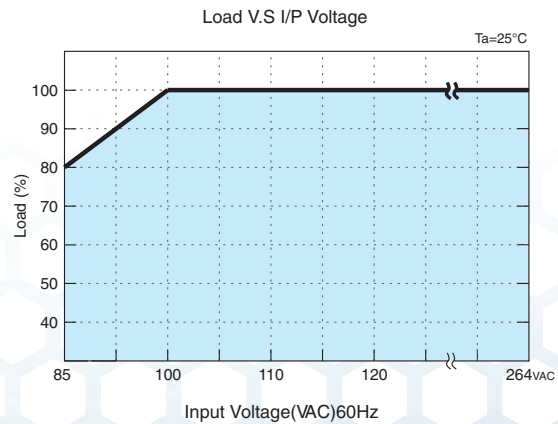
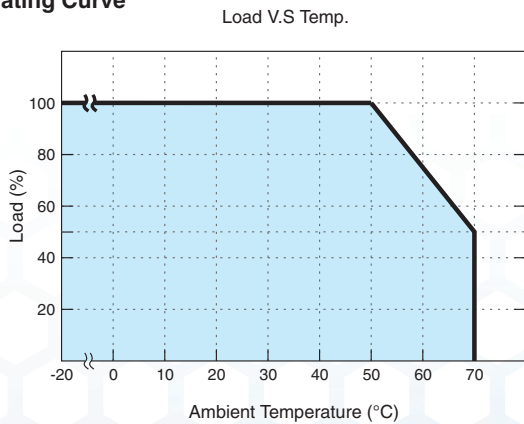

Note: All dimensions are in millimeters, to convert to inches multiply by 0.03937.