

# Altech Corp.®

Serving the Automation & Control Industry since 1984

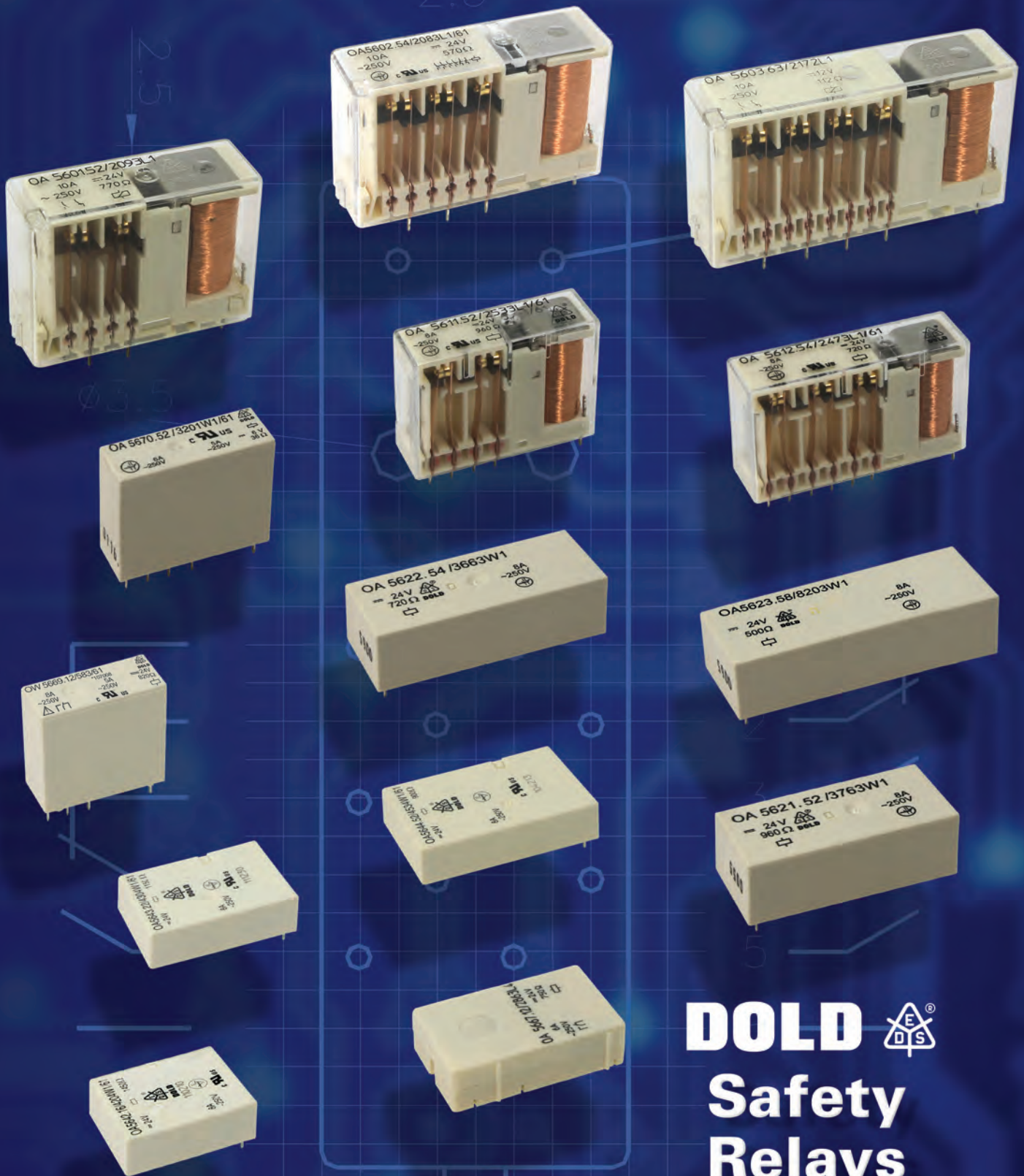

ISO 9001  
OMI-SAI Global



**DOLD**   
**Safety  
Relays**

# Altech Corp.®

Since 1984, Altech Corporation has grown to become a leading supplier of automation and industrial control components. Headquartered in Flemington, NJ, Altech has an experienced staff of engineering, manufacturing and sales personnel to provide the highest quality products with superior service. This is the Altech Commitment!

Altech's line of safety relays are manufactured by **DOLD**, a company well known in Europe for its quality safety relays. The products presented in this catalog will help you meet requirements of Machinery Directive EMD 89/392 EEC, important international safety standards, CE-marking demand, and more, when exporting your machinery or equipment.

## What is a Safety Relay?

A safety relay contains force guided contacts; they are also known as captive, locked or positive guided contacts. Force guidance in a relay means that the contacts in a contact set must be mechanically linked together so that it is impossible for the NO (normally open) and NC (normally closed) contacts to be closed at the same time. The contacts are linked so that no one contact in a relay can change state without changing all the contacts in that relay. There must be a 0.5 mm minimum air gap between the open contacts for the entire service life of the relay, even in the case of a failure. The force guidance of the relay contacts must always be preserved even when a relay part fails to function correctly.

Our technical experts welcome the opportunity to answer your technical questions and provide solutions to your automation and control problems. Give us a call or visit [www.altechcorp.com](http://www.altechcorp.com).



## Quality Commitment

*Altech's control components meet diverse national and international standards such as UL, NEC, CSA, IEC, VDE and more. Altech provides superior customer service and delivery through Total Quality Management and Continuous Process Improvement. Altech is ISO 9001 approved. We perform these services with honesty and integrity and are committed to achieve these goals.*





Safety relays with forced-guided contacts are the core components for safety devices and are indispensable when designing safety circuits. Safety devices are designed to protect man and machine as demanded in OSHA CFR 1910 Regulations “General Requirements for All Machinery”, and which is a mandatory requirement of the European Machinery Directive EMD 2006/42/EC.

DOLD safety relays, manufactured according to DIN EN 50205 and IEC/EN61810 are approved for use in safety applications to IEC 60204, EN 60204, DIN/VDE 0113, as well as Escalator Standard EN 115/06.95 and Elevator Standard EN 81-1 (electric) and EN81-2 (hydraulic), and in safety related parts of control systems in IEC/EN 62061 and EN ISO 13849. > *Read more on page 45.*



**OA 5642/43/44**  
1 NO/1 NC, 2NO/1NC,  
2NO/2NC, 3NO/1NC

**4-5**



**OA 5611**  
2 NO/2 NC, 3 NO/1 NC

**18-19**



**OA/OW 5669**  
1 NO/1 NC, 2 CO, 2 NO, 2 NC

**6-7**



**OA 5612**  
2 NO/4 NC, 3 NO/3 NC, 4 NO/2 NC

**20-21**

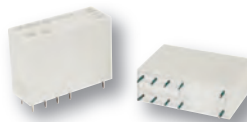

**OA/OW 5670**  
2 NO/2 NC, 3 NO/1 NC

**8-9**



**OA 5601**  
2 NO/2 NC, 3 NO/1 NC

**22-23**



**OA 5621 / OA 5621S**  
3 NO/1 NC, 2 NO/2 NC

**10-11**



**OA 5602**  
2 NO/4 NC, 3 NO/3 NC, 4 NO/2 NC

**24-25**



**OA 5622 / OA 5622S**  
2 NO/4 NC, 3 NO/3 NC,  
4 NO/2 NC, 5 NO/1 NC

**12-13**



**OA 5603**  
7 NO/1 NC, 6 NO/2 NC, 5 NO/3 NC,  
4 NO/4 NC, 3 NO/5 NC, 2 NO/6 NC

**26-27**



**OA 5623 / OA 5623S**  
4 NO/4 NC, 5 NO/3 NC,  
6 NO/2 NC, 7 NO/1 NC

**14-15**



**Safety Relay Modules**

DPDT, Isolated .....30-31  
DPDT, Bussed.....32-33  
4 Pole, 8 Amp .....34-35  
4 Pole, 10 Amp .....36-37  
6 Pole, 8 Amp .....38-39  
6 Pole, 10 Amp .....40-41  
8 Pole, 10 Amp .....42-43



**OA 5667 / OA 5667S**  
1 NO/1 NC, 2 CO

**16-17**

Accessories.....44  
Applications .....45  
Terminology ..... 46-48

Index .....49  
Terms & Conditions.....50

# Safety Relay OA 5642/43/44

## Features

- 2-4 output contacts
- International approvals: TÜV, UL, cUL
- Quality control check for each safety relay
- Forced-guided contacts, all gold flash plated
- Contact Gap > 0.5 mm throughout life of relay
- Various contact materials, mixed contact material optional
- High coil voltage range
- High switching voltage
- High breakdown voltage: contact/coil  $\geq$  4 kV
- High creeping distance: contact/coil  $\geq$  5.5 mm  
contact/contact  $\geq$  5.5 mm
- Protection Rating RTIII wash proof
- Compact size- only 10.3 mm height
- SMD component can be mounted under relay
- Custom design available,
  - coil voltage
  - operate/release time
  - contact pressure
  - coil resistance
- Special reflow solder version available for SMD applications
- Standard Pack:
  - OA5642:** 32 piece sleeve or 320 piece case
  - OA5643:** 28 piece sleeve or 280 piece case
  - OA5644:** 20 piece sleeve or 200 piece case

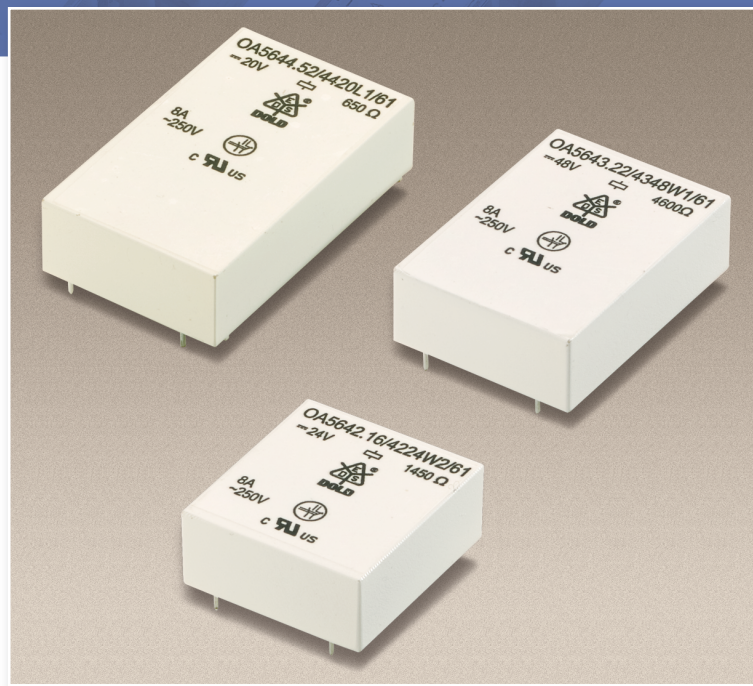

## Technical Data

- **Nominal Coil Voltage** .....6, 12, 21, 24, 48, 60, 110, DC
- **Coil Power Dissipation** .....0.4/0.5/0.65 W
- **Min./Max. Switching Voltage** .....AC/DC10V / 250VDC, 400VAC<sup>1</sup>
- **Min./Max. Switching Current** .....10mA / 8 A<sup>1</sup>
- **Min./Max. Switching Power — DC** .....0.1W / 200W<sup>1</sup>
- **Min./Max. Switching Power — AC** .....0.1VA / 2000VA<sup>1</sup>
- **Contact Switching Rate** .....20 operations per second
- **Relay Operate Time** ..... $\leq$  10 ms
- **Relay Release Time** ..... $\leq$  5 ms
- **Operation Vibration** .....0.35 mm Ampl. max  
@ 10...60Hz, 5g max
- **Protection Rating** .....RTIII wash proof
- **Contact Arrangements** .....1NO/1NC, 2NO/1NC, 2NO/2NC, 3NO/1NC,
- **Contact Material** .....AgNi10+0.2 $\mu$ mAu, AgSnO<sub>2</sub>+0.2 $\mu$ mAu, AgNi10+5 $\mu$ mAu
- **Mechanical Life** .....>40x10<sup>6</sup> operation cycles
- **Electrical Life** .....>10<sup>5</sup> operation cycles @ 230V AC, 8A, cos  $\varphi$ =1
- **Ambient Temperature** .....-40...+85°C
- **Cover Material** .....Thermoplastic
- **Weight** .....14/15/16 g
- **Wave Solder Temperature/Duration** .....260°C/5s
- More detailed data upon request

## Diagrams

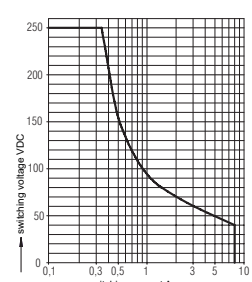
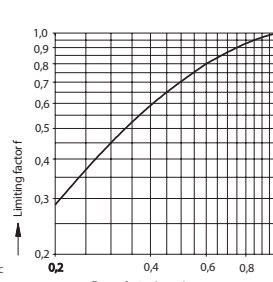
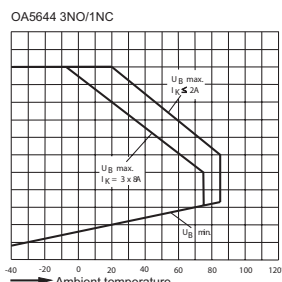
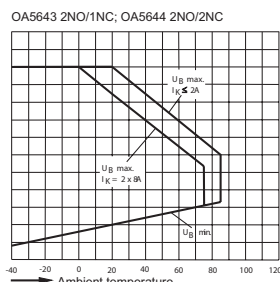
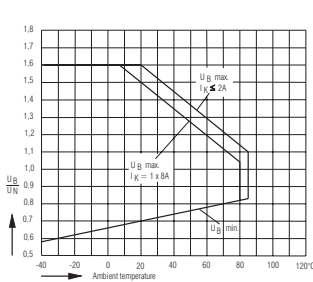

Relay operation voltage vs. ambient temperature

<sup>1</sup> AgNi10+5 $\mu$ mAu contact material has limited switching capacity (Min./Max. 2V/60VAC/DC, 2mA/0.3A, 10mVA/12VA, 10mW/12W)

Operations =  
Operations (ohmic) x  
limitation factor F

Limitation factor for inductive loads

Operations =  
safe breaking, no continuous arcing,  
max. 1 switching cycle / s  
Maximum switching  
power curve

## Relay Data

## Ordering Information

Rated Voltage	Voltage Range	Coil Resistance (10%)	1 NO/1 NC Type	Coil Resistance (10%)	2NO/1NC Type	Coil Resistance (10%)	3NO/1NC Type	2NO/2NC Type
6V	4.2 - 9.6V	90 Ω	56.OA42.0611□	70 Ω	56.OA43.0621□	55 Ω	56.OA44.0631□	56.OA44.0622□
12V	8.4 - 19.2V	370 Ω	56.OA42.1211□	290 Ω	56.OA43.1221□	230 Ω	56.OA44.1231□	56.OA44.1222□
21V	15.0 - 33.6V	1050 Ω	56.OA42.2111□	840 Ω	56.OA43.2121□	680 Ω	56.OA44.2131□	56.OA44.2122□
24V	16.8 - 38.4V	1450 Ω	56.OA42.2411□	1150 Ω	56.OA43.2421□	900 Ω	56.OA44.2431□	56.OA44.2422□
48V	33.6 - 76.8V	6000 Ω	56.OA42.4811□	4600 Ω	56.OA43.4821□	3600 Ω	56.OA44.4831□	56.OA44.4822□
60V	42.0 - 96.0V	9250 Ω	56.OA42.6011□	7100 Ω	56.OA43.6021□	5600 Ω	56.OA44.6031□	56.OA44.6022□
110V	77.0 - 176.0V	31000 Ω	56.OA42.1111□	24000 Ω	56.OA43.1121□	18500 Ω	56.OA44.1131□	56.OA44.1122□

Contact Material, Example: **C** AgSnO<sub>2</sub>+2μmAu

**N** AgNi10+.2μmAu

**S** AgNi10+5μmAu

## Dimensions & Pin Configurations

### 5642

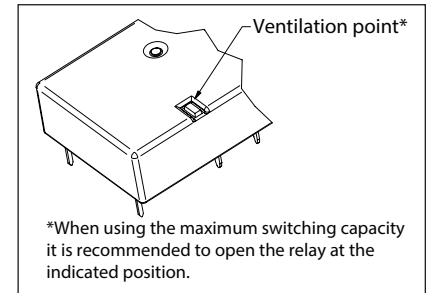
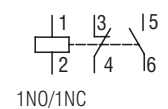
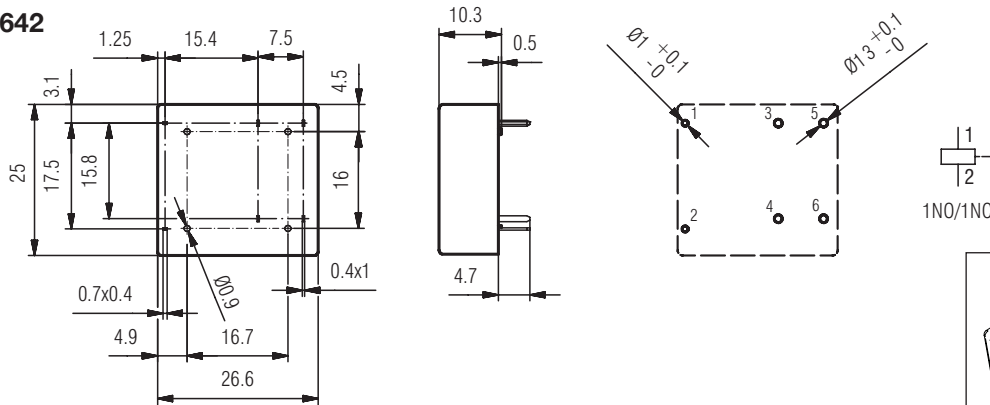

### 5643

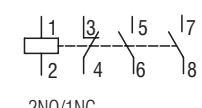
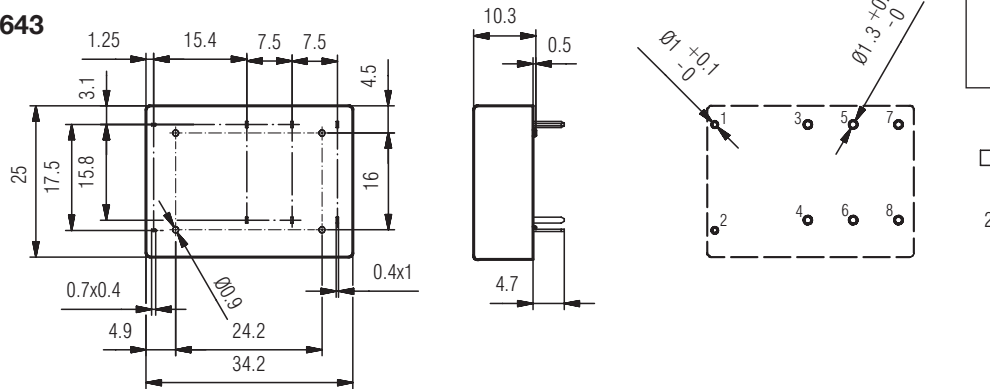

### 5644

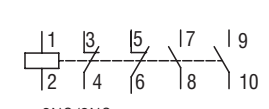
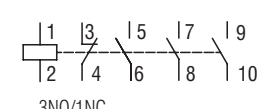
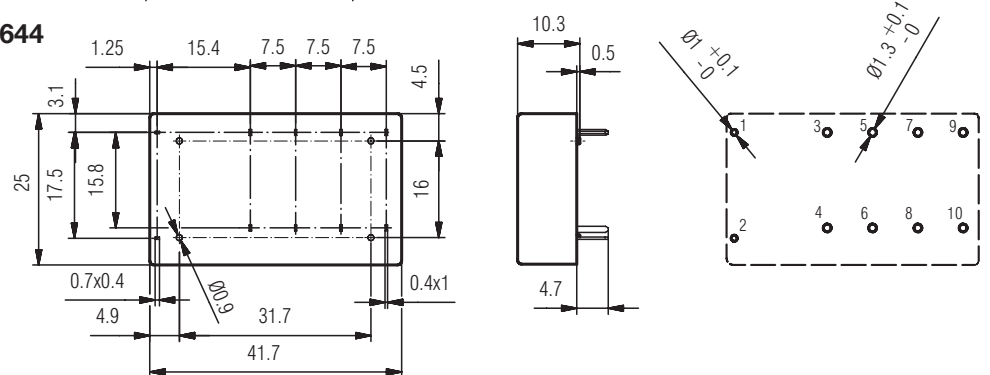

Note: All dimensions are shown in millimeters. To convert to inches, divide by 25.4.

# Safety Relay OA/OW 5669

## Features

- 2 output contacts
- International approvals:  
TÜV, UL, cUL
- Quality control check for each safety relay
- Forced-guided contacts, all gold flash plated
- Contact Gap > 0.5 mm throughout life of relay
- Various contact materials,  
mixed contact material optional
- High coil voltage range
- High breakdown voltage: contact/coil  $\geq 4$  KV
- High creeping distance: contact/contact  $\geq 4$  KV  
contact/coil  $\geq 8$  mm  
contact/contact  $\geq 5.5$  mm
- Protection Rating  
OA Version: RTII solder line proof  
OW Version: RTIII wash proof
- Custom design available  
-coil voltage                      -coil resistance  
-contact pressure                -operate/release time
- Standard Pack: 56 piece sleeve or 280 piece case

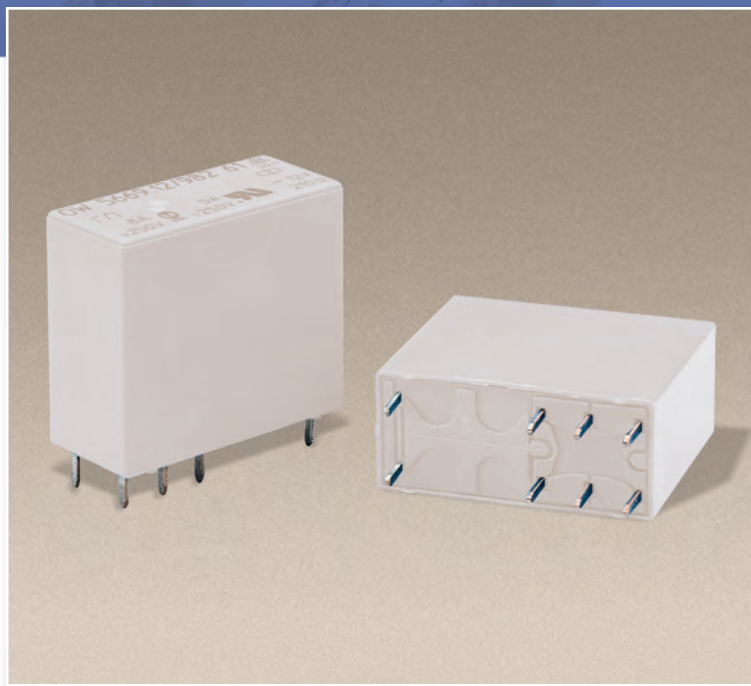

GERMANY



USA/CANADA  
E146415

## Technical Data

- **Nominal Coil Voltage** ..... 6, 12, 20, 24, 48, 60, 110, DC
- **Coil Power Dissipation** ..... 0.7 W
- **Min./Max. Switching Voltage** ..... AC/DC10V / 250VDC, 400VAC<sup>1</sup>
- **Min./Max. Switching Current** ..... 10mA / 8 A (2 x 5A simultaneous)<sup>1</sup>
- **Min./Max. Switching Power – DC** ..... 0.1W / 200W<sup>1</sup>
- **Min./Max. Switching Power – AC** ..... 0.1VA / 2000VA<sup>1</sup>
- **Contact Switching Rate** ..... 10 operations per second
- **Relay Operate Time** .....  $\leq 15$  ms
- **Relay Release Time** .....  $\leq 12$  ms
- **Operation Vibration** ..... 10...200Hz; NC 2g; NO 10g
- **Contact Arrangements** ..... 1NO/1NC, 2CO, 2NO\*, 2NC\*
- **Contact Material** ..... AgNi10+0.2 $\mu$ mAu  
..... AgSnO<sub>2</sub>+0.2 $\mu$ mAu, AgNi10+5 $\mu$ mAu
- **Mechanical Life** .....  $\geq 50 \times 10^6$  operation cycles
- **Electrical Life** .....  $> 2 \times 10^5$  operation cycles  
..... @ 230V AC, 6A,  $\cos \varphi = 1$
- **Ambient Temperature** ..... -40...+70°C
- **Cover Material** ..... Polyamide 6
- **Weight** ..... 19 g
- **Wave Solder Temperature/Duration** ..... 260°C/5s
- More detailed data upon request

## Diagrams

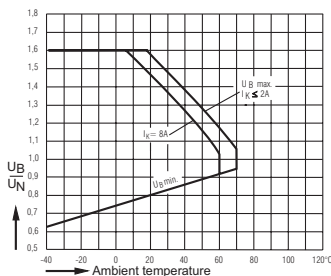

Relay operation voltage vs. ambient temperature

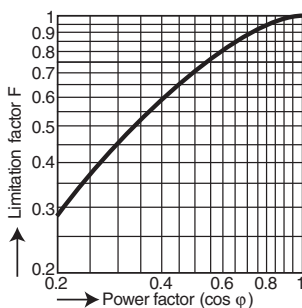

Operations =  
Operations (ohmic) x limitation factor F

Limitation factor for inductive loads

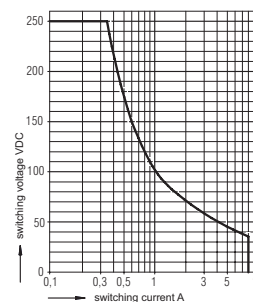

safe breaking, no continuous arcing,  
max. 1 switching cycle / s

Maximum switching power curve

<sup>1</sup> AgNi10+5 $\mu$ mAu contact material has limited switching capacity  
(Min./Max. 2V/60VAC/DC, 2mA/0.3A, 10mVA/12VA, 10mW/12W)

\*Special order.

## Relay Data

## Ordering Information

Rated Voltage	Voltage Range	Coil Resistance (10%)	1 NO/1 NC Type	2 CO Type	2 NO* Type	2 NC* Type
6V	4.8 - 9.6V	50 Ω	56.O□69.0611□	56.O□69.0600□	56.O□69.0620□	56.O□69.0602□
10V	8.0 - 16.0V	150 Ω	56.O□69.1011□	56.O□69.1000□	56.O□69.1020□	56.O□69.1002□
12V	9.6 - 19.2V	210 Ω	56.O□69.1211□	56.O□69.1200□	56.O□69.1220□	56.O□69.1202□
20V	16.0 - 32.0V	580 Ω	56.O□69.2011□	56.O□69.2000□	56.O□69.2020□	56.O□69.2002□
24V	19.2 - 38.4V	820 Ω	56.O□69.2411□	56.O□69.2400□	56.O□69.2420□	56.O□69.2402□
48V	38.4 - 76.8V	3200 Ω	56.O□69.4811□	56.O□69.4800□	56.O□69.4820□	56.O□69.4802□
60V	48.0 - 96.0V	5200 Ω	56.O□69.6011□	56.O□69.6000□	56.O□69.6020□	56.O□69.6002□
110V	88.0 - 176.0V	18000 Ω	56.O□69.1111□	56.O□69.1100□	56.O□69.1120□	56.O□69.1102□

Protection Class, Example: \_\_\_\_\_

- A** RTII solder line proof
- W** RTIII wash proof

Contact Material, Example: **C** AgSnO<sub>2</sub>+0.2μmAu

- N** AgNi10+0.2μmAu
- S** AgNi10+5μmAu

## Footprints (solder side)

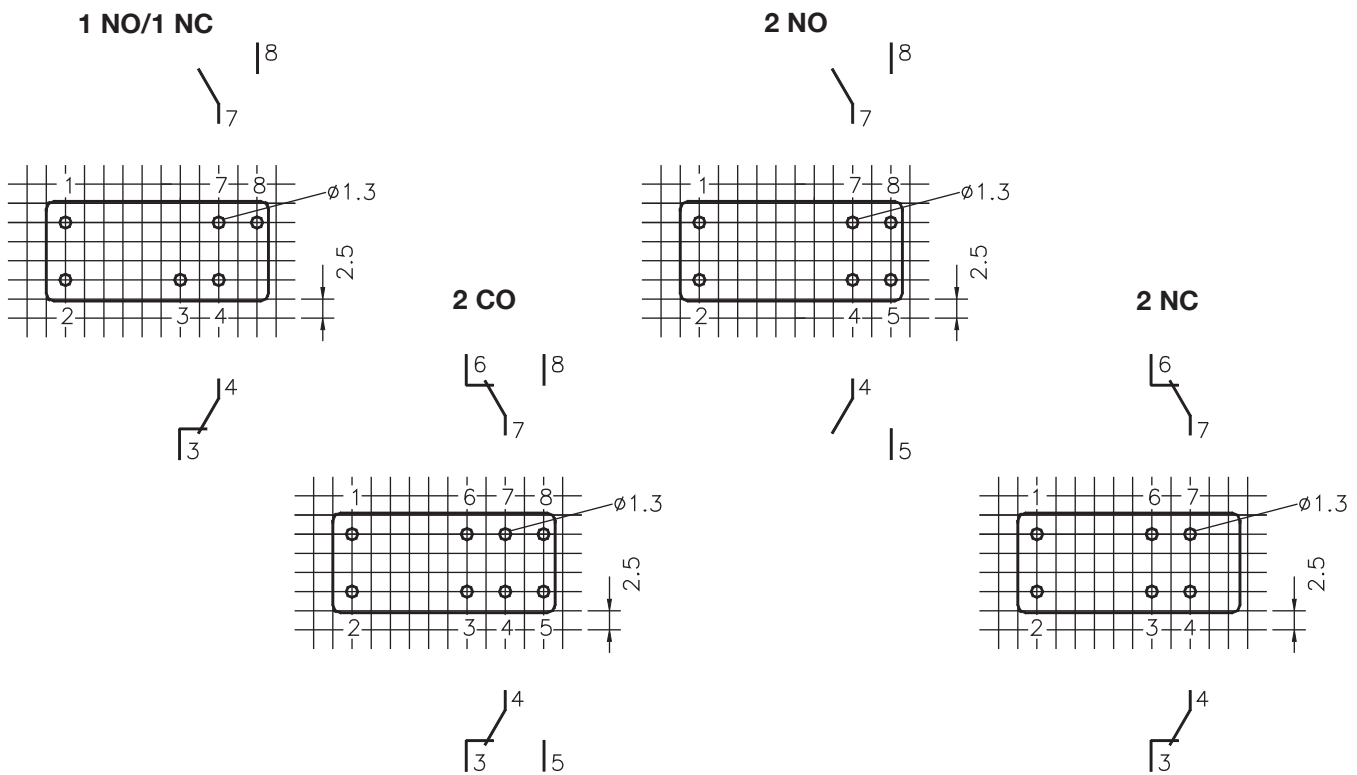

## Dimensions

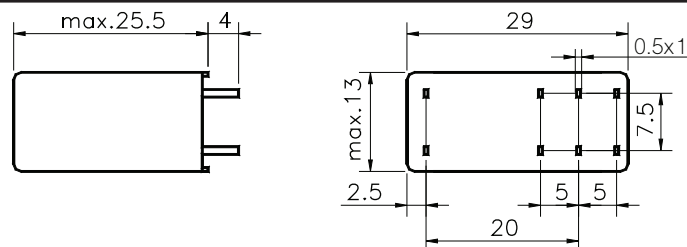

Note: All dimensions are shown in millimeters. To convert to inches, divide by 25.4.

\*Special order.

# Safety Relay OA/OW 5670

## Features

- 4 output contacts
- International approvals:  
TÜV, UL, cUL
- Quality control check for each safety relay
- Forced-guided contacts, all gold flash plated
- Contact Gap > 0.5 mm throughout life of relay
- Various contact materials,  
mixed contact material optional
- High coil voltage range
- High breakdown voltage: contact/coil  $\geq 4$  KV
- High creeping distance: contact/contact  $\geq 3$  KV  
contact/coil  $\geq 8$  mm  
contact/contact  $\geq 4.5$  mm
- Protection Rating  
OA Version: RTII solder line proof  
OW Version: RTIII wash proof
- Custom design available,  
-coil voltage                      -coil resistance  
-contact pressure                -operate/release time
- Standard Pack: 42 piece sleeve or 210 piece case



## Technical Data

- **Nominal Coil Voltage** .....6, 12, 20, 24, 48, 60, 110, DC
- **Coil Power Dissipation** .....1.0 W
- **Min./Max. Switching Voltage** .....AC/DC10V / 250VDC, 400VAC<sup>1</sup>
- **Min./Max. Switching Current** .....10mA / 6 A (3 x 6A simultaneous)<sup>1</sup>
- **Min./Max. Switching Power – DC** .....0.1W / 200W<sup>1</sup>
- **Min./Max. Switching Power – AC** .....0.1VA / 1500VA<sup>1</sup>
- **Contact Switching Rate** .....10 operations per second
- **Relay Operate Time** .....11 ms
- **Relay Release Time** .....6 ms
- **Operation Vibration** .....10...200Hz; NC 5g; NO 10g
- **Contact Arrangements** .....2NO/2NC, 3NO/1NC
- **Contact Material** .....AgNi10+0.2 $\mu$ mAu  
.....AgSnO<sub>2</sub>+0.2 $\mu$ mAu, AgNi10+5 $\mu$ mAu
- **Mechanical Life** ..... $\geq 50 \times 10^6$  operation cycles
- **Electrical Life** .....AgNi10 >2.6 $\times 10^5$   
.....operation cycles @ 230V AC, 6A, cos  $\phi$ =1
- **Ambient Temperature** .....-40...+75°C
- **Cover Material** .....Polyamide 6
- **Weight** .....21 g
- **Wave Solder Temperature/Duration** .....260°C/5s
- More detailed data upon request

## Diagrams

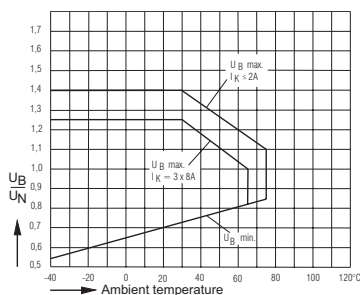

Relay operation voltage vs. ambient temperature

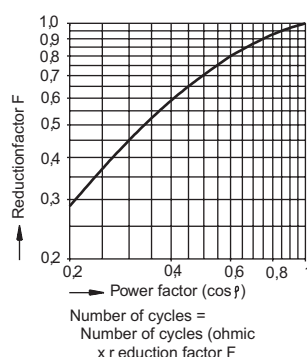

Limitation factor for inductive loads

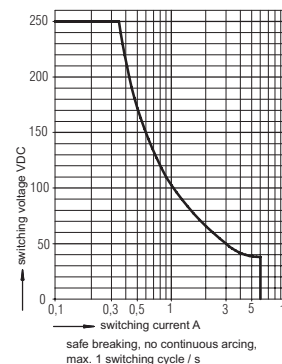

Maximum switching power curve

<sup>1</sup> AgNi10+5 $\mu$ mAu contact material has limited switching capacity (Min./Max. 2V/60VAC/DC, 2mA/0.3A, 10mVA/12VA, 10mW/12W)



Relay Data			Ordering Information	
Rated Voltage	Voltage Range	Coil Resistance (10%)	2 NO/2 NC Type	3 NO/1 NC Type
6V	4.2 - 8.4V	36 Ω	56.O□70.0622□	56.O□70.0631□
12V	8.4 - 16.8V	150 Ω	56.O□70.1222□	56.O□70.1231□
20V	14.0 - 28.0V	400 Ω	56.O□70.2022□	56.O□70.2031□
24V	16.8 - 33.6V	580 Ω	56.O□70.2422□	56.O□70.2431□
48V	33.6 - 67.2V	2300 Ω	56.O□70.4822□	56.O□70.4831□
60V	42.0 - 84.0V	3600 Ω	56.O□70.6022□	56.O□70.6031□
110V	77.0 - 154.0V	12100 Ω	56.O□70.1122□	56.O□70.1131□

Protection Class, Example:

- A** RTII solder line proof
- W** RTIII wash proof

Contact Material, Example:

- C** AgSnO<sub>2</sub>+0.2μmAu
- N** AgNi10+0.2μmAu
- S** AgNi10+5μmAu

## Footprints (solder side)

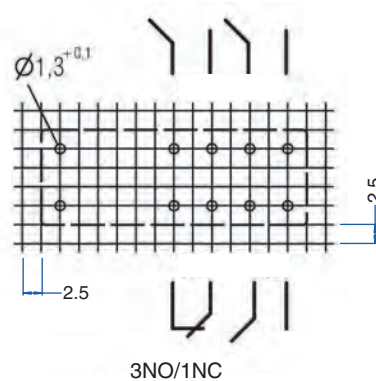
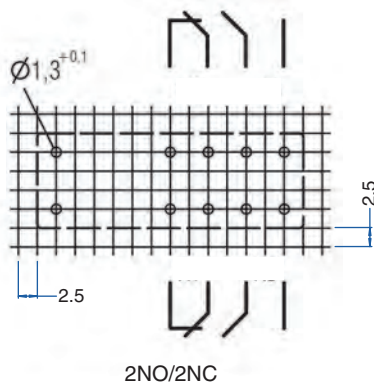

## Dimensions

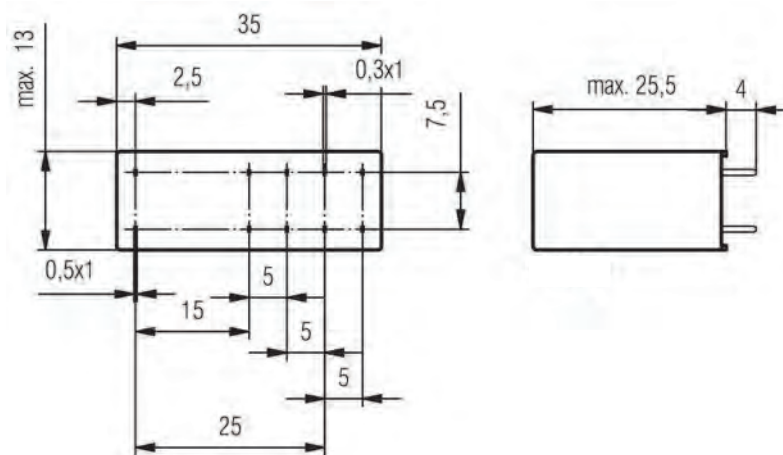

Note: All dimensions are shown in millimeters. To convert to inches, divide by 25.4.

# Safety Relay

## OA 5621 / OA 5621S

### Features

- 4 output contacts
- International approvals: TÜV, UL, cUL
- Quality control check for each safety relay
- Forced-guided contacts, all gold flash plated
- Contact Gap > 0.5 mm throughout life of relay
- Various contact materials, mixed contact material optional
- High coil voltage range
- High breakdown voltage: contact/coil  $\geq 4$  KV
- High creeping distance: contact/coil  $\geq 5.5$  mm  
contact/contact  $\geq 5.5$  mm
- Protection Rating RTIII wash proof
- Custom design available,
  - coil voltage
  - coil resistance
  - contact pressure
  - operate/release time
  - gold plated double contacts
- Standard Pack: 25 piece sleeve or 250 piece case

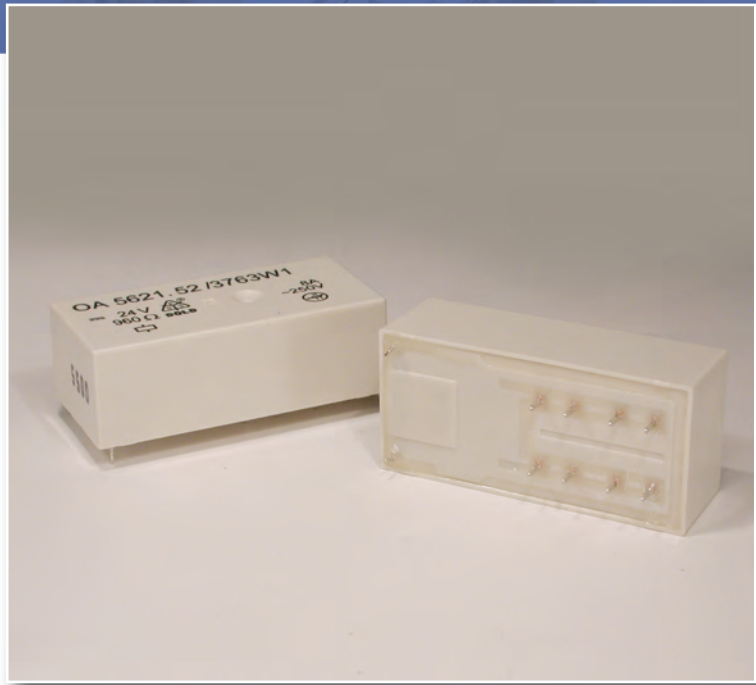

### Technical Data

- **Nominal Coil Voltage** .....6, 12, 24, 48, 60, 110, DC
- **Coil Power Dissipation** .....0.6 W
- **Min./Max. Switching Voltage** .....AC/DC10V / 250VDC, 400VAC<sup>1</sup>
- **Min./Max. Switching Current**.....10mA / .....8 A (3 x 8A simultaneous)<sup>1</sup>
- **Min./Max. Switching Power — DC**.....0.1W / 200W<sup>1</sup>
- **Min./Max. Switching Power — AC**.....0.1VA / 2000VA<sup>1</sup>
- **Contact Switching Rate** .....10 operations per second
- **Relay Operate Time**.....12 ms
- **Relay Release Time**.....8 ms
- **Operation Vibration** .....0.35 mm Ampl. max .....@ 10...200Hz, 5g max
- **Contact Arrangements**.....3NO/1NC, 2NO/2NC
- **Contact Material**.....AgNi10+0.2 $\mu$ mAu .....AgSnO<sub>2</sub>+0.2 $\mu$ mAu, AgNi10+5 $\mu$ mAu
- **Mechanical Life** .....>20x10<sup>6</sup> operation cycles
- **Electrical Life** .....AgSnO<sub>2</sub> >1.5x10<sup>5</sup>, AgNi10 >1.0x10<sup>5</sup> .....operation cycles @ 230V AC, 8A, cos  $\phi$ =1
- **Ambient Temperature** .....-40...+80°C
- **Cover Material** .....Polyamide 6
- **Weight**.....35 g
- **Wave Solder Temperature/Duration** .....260°C/5s
- More detailed data upon request

### Diagrams

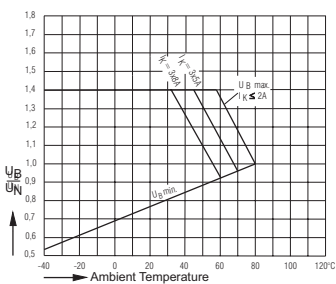

Relay operation voltage vs. ambient temperature

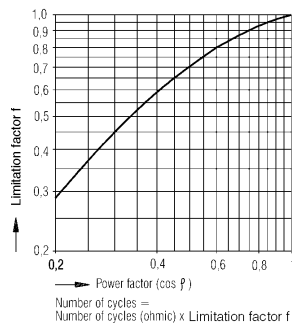

Limitation factor for inductive loads

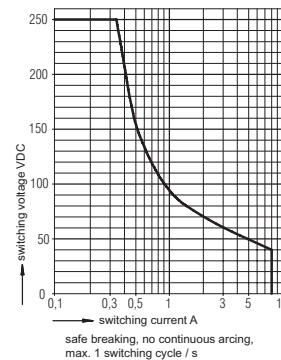

Maximum switching power curve

<sup>1</sup> AgNi10+5 $\mu$ mAu contact material has limited switching capacity (Min./Max. 2V/60VAC/DC, 2mA/0.3A, 10mVA/12VA, 10mW/12W)

### Relay Data

### Ordering Information

Rated Voltage	Voltage Range	Coil Resistance (10%)	3 NO/1 NC Type	2 NO/2 NC Type	3 NO/1 NC S-Type	2 NO/2 NC S-Type
6V	4.5 - 8.4V	60 Ω	56.OA21.0631□	56.OA21.0622□	56.OA21S.0631□	56.OA21S.0622□
12V	9.0 - 16.8V	240 Ω	56.OA21.1231□	56.OA21.1222□	56.OA21S.1231□	56.OA21S.1222□
24V	18.0 - 33.6V	960 Ω	56.OA21.2431□	56.OA21.2422□	56.OA21S.2431□	56.OA21S.2422□
48V	36.0 - 67.2V	3840 Ω	56.OA21.4831□	56.OA21.4822□	56.OA21S.4831□	56.OA21S.4822□
60V	45.0 - 84.0V	6000 Ω	56.OA21.6031□	56.OA21.6022□	56.OA21S.6031□	56.OA21S.6022□
110V	82.5 - 154.0V	20000 Ω	56.OA21.1131□	56.OA21.1122□	56.OA21S.1131□	56.OA21S.1122□

Contact Material, Example: CAgSnO<sub>2</sub>+2μmAu  
NAgNi10+.2μmAu  
SAgNi10+5μmAu

## Footprints (solder side)

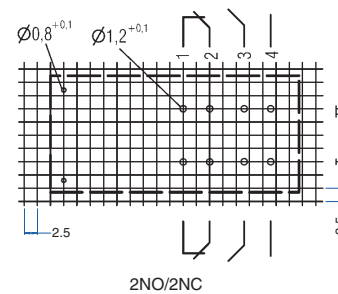
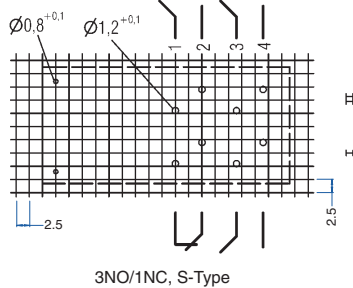
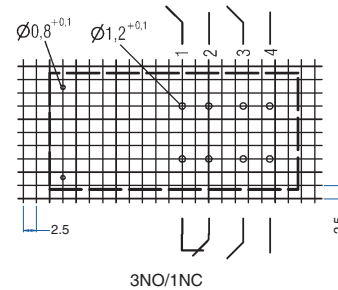
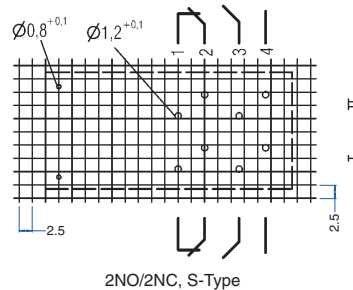

## Dimensions

### S-Type

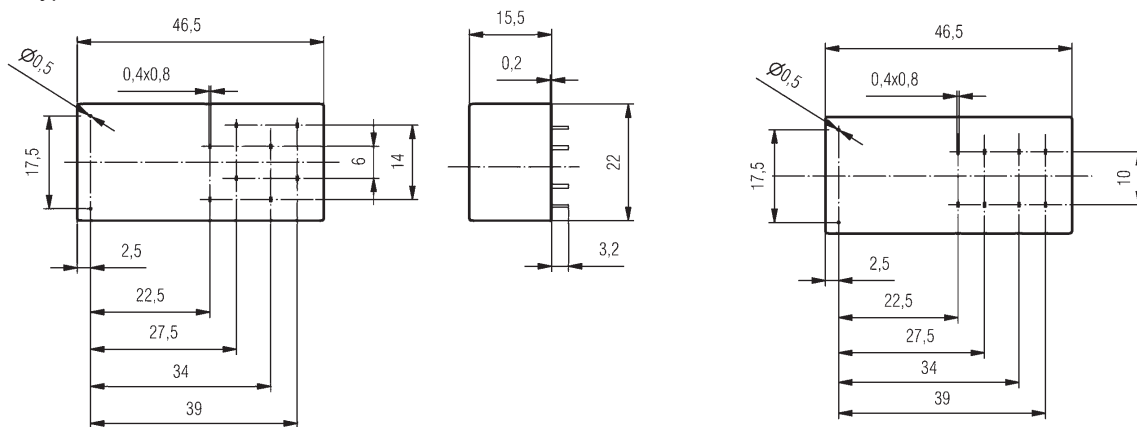

Note: All dimensions are shown in millimeters. To convert to inches, divide by 25.4.

# Safety Relay OA 5622 / OA 5622S

## Features

- 6 output contacts
- International approvals:  
TÜV, UL, cUL
- Quality control check for each safety relay
- Forced-guided contacts, all gold flash plated
- Contact Gap > 0.5 mm throughout life of relay
- Various contact materials,  
mixed contact material optional
- High coil voltage range
- High breakdown voltage: contact/coil  $\geq 4$  KV  
contact/contact  $\geq 4$  KV
- High creeping distance: contact/coil  $\geq 5.5$  mm  
contact/contact  $\geq 5.5$  mm
- Protection Rating RTIII wash proof
- Custom design available,
  - coil voltage
  - coil resistance
  - contact pressure
  - operate/release time
  - gold plated double contacts
- Standard Pack: 20 piece sleeve or 200 piece case

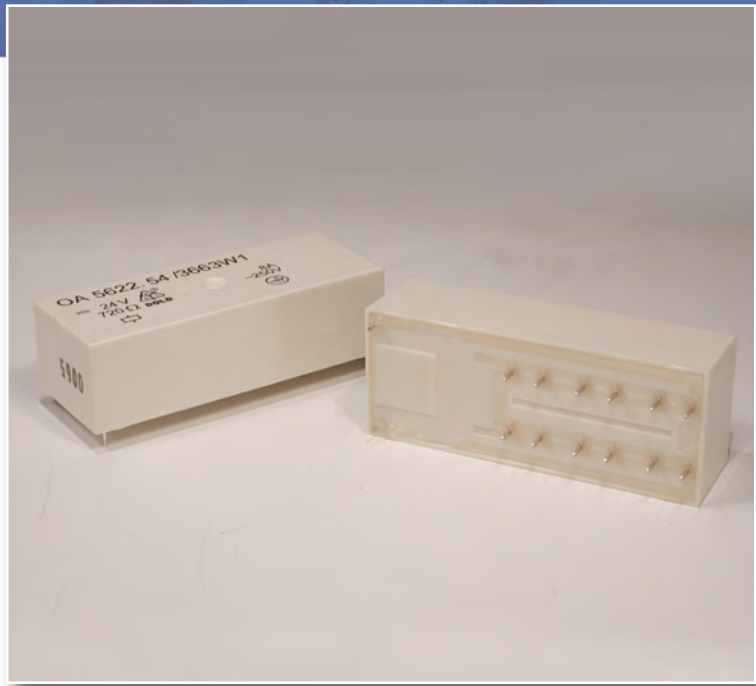

## Technical Data

- **Nominal Coil Voltage** .....6, 12, 24, 48, 60, 110, DC
- **Coil Power Dissipation\*** .....0.8 W
- **Min./Max. Switching Voltage** .....AC/DC10V / 250VDC, 400VAC<sup>1</sup>
- **Min./Max. Switching Current** .....10mA / 8 A (5 x 8A simultaneous)<sup>1</sup>
- **Min./Max. Switching Power – DC** .....0.1W / 200W<sup>1</sup>
- **Min./Max. Switching Power – AC** .....0.1VA / 2000VA<sup>1</sup>
- **Contact Switching Rate** .....10 operations per second
- **Relay Operate Time** .....12 ms
- **Relay Release Time** .....8 ms
- **Operation Vibration** .....0.35 mm Ampl. max  
.....@ 10...200Hz, 5g max
- **Contact Arrangements** .....2NO/4NC, 3NO/3NC, 4NO/2NC, 5NO/1NC
- **Contact Material** .....AgNi10+0.2 $\mu$ mAu  
.....AgSnO<sub>2</sub>+0.2 $\mu$ mAu, AgNi10+5 $\mu$ mAu
- **Mechanical Life** .....>20x10<sup>6</sup> operation cycles
- **Electrical Life** .....AgSnO<sub>2</sub> >1.5x10<sup>5</sup>, AgNi10 >10<sup>5</sup>  
.....operation cycles @ 230V AC, 8A, cos  $\varphi$ =1
- **Ambient Temperature** .....-40...+80°C
- **Cover Material** .....Polyamide 6
- **Weight** .....38 g
- **Wave Solder Temperature/Duration** .....260°C/5s
- More detailed data upon request

## Diagrams

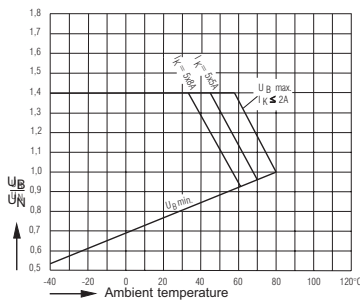

Relay operation voltage vs. ambient temperature

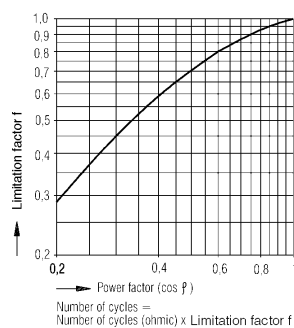

Limitation factor for inductive loads  
Number of cycles = Number of cycles (ohmic) x Limitation factor f

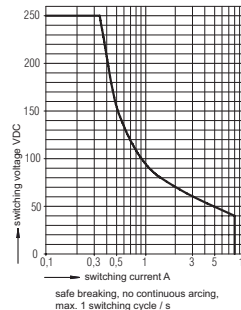

Maximum switching power curve  
safe breaking, no continuous arcing,  
max. 1 switching cycle / s

<sup>1</sup> AgNi10+5 $\mu$ mAu contact material has limited switching capacity (Min./Max. 2V/60VAC/DC, 2mA/0.3A, 10mVA/12VA, 10mW/12W)

\*2NO/4NC: 0.9W

## Relay Data

## Ordering Information

Rated Voltage	Voltage Range	Coil Resistance (10%)	2 NO/4 NC Type	Coil Resistance (10%)	3 NO/3 NC Type	4 NO/2 NC Type	5 NO/1 NC Type
6V	4.5 - 8.4V	38 Ω	56.OA22.0624□	45 Ω	56.OA22.0633□	56.OA22.0642□	56.OA22.0651□
12V	9.0 - 16.8V	150 Ω	56.OA22.1224□	180 Ω	56.OA22.1233□	56.OA22.1242□	56.OA22.1251□
24V	18.0 - 33.6V	600 Ω	56.OA22.2424□	720 Ω	56.OA22.2433□	56.OA22.2442□	56.OA22.2451□
48V	36.0 - 67.2V	2425 Ω	56.OA22.4824□	2880 Ω	56.OA22.4833□	56.OA22.4842□	56.OA22.4851□
60V	45.0 - 84.0V	3790 Ω	56.OA22.6024□	4500 Ω	56.OA22.6033□	56.OA22.6042□	56.OA22.6051□
110V	82.5 - 154.0V	12735 Ω	56.OA22.1124□	15125 Ω	56.OA22.1133□	56.OA22.1142□	56.OA22.1151□

For S-Type:

Please specify **S** when ordering:

Example: 56.OA22S.\_\_\_\_□

Contact Material, Example: C AgSnO<sub>2</sub>+2μmAu

N AgNi10+.2μmAu

S AgNi10+5μmAu

## Footprints (solder side)

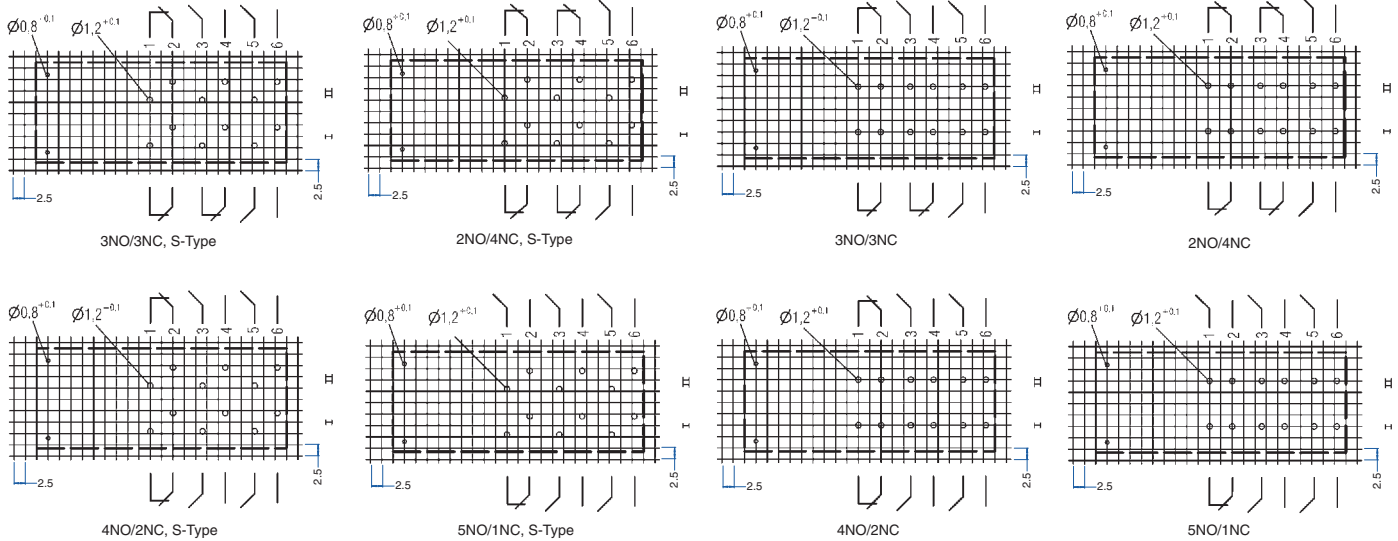

## Dimensions

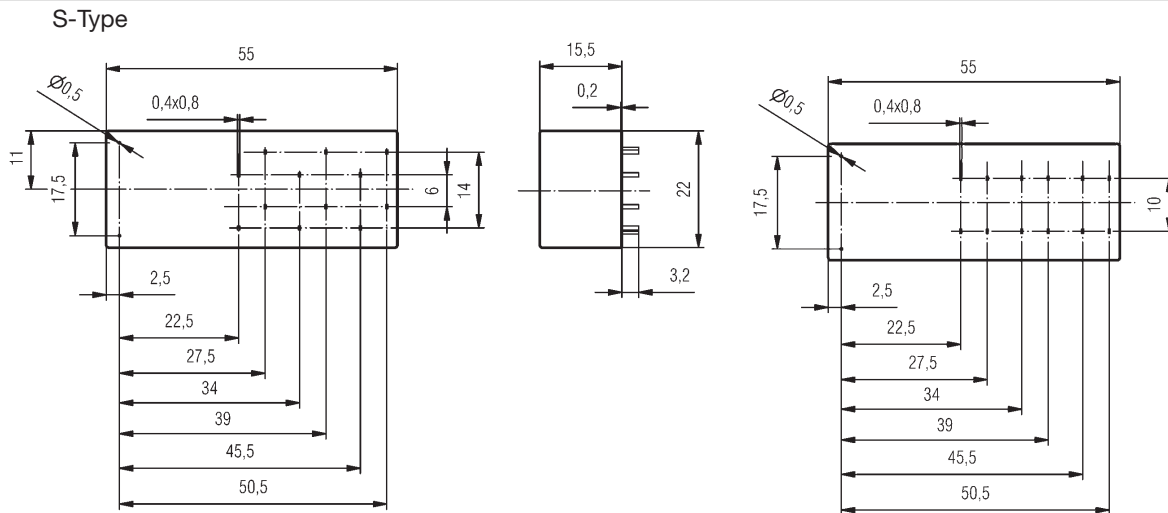

Note: All dimensions are shown in millimeters. To convert to inches, divide by 25.4.

# Safety Relay

## OA 5623 / OA 5623S

### Features

- 8 output contacts
- International approvals: TÜV, UL, cUL
- Quality control check for each safety relay
- Forced-guided contacts, all gold flash plated
- Contact Gap > 0.5 mm throughout life of relay
- Various contact materials, mixed contact material optional
- High coil voltage range
- High breakdown voltage: contact/coil  $\geq 4$  KV  
contact/contact  $\geq 4$  KV
- High creeping distance: contact/coil  $\geq 5.5$  mm  
contact/contact  $\geq 5.5$  mm
- Protection Rating RTIII wash proof
- Custom design available,
  - coil voltage
  - coil resistance
  - contact pressure
  - operate/release time
  - gold plated double contacts
- Bistable/latching version available
- Standard Pack: 15 piece sleeve or 150 piece case

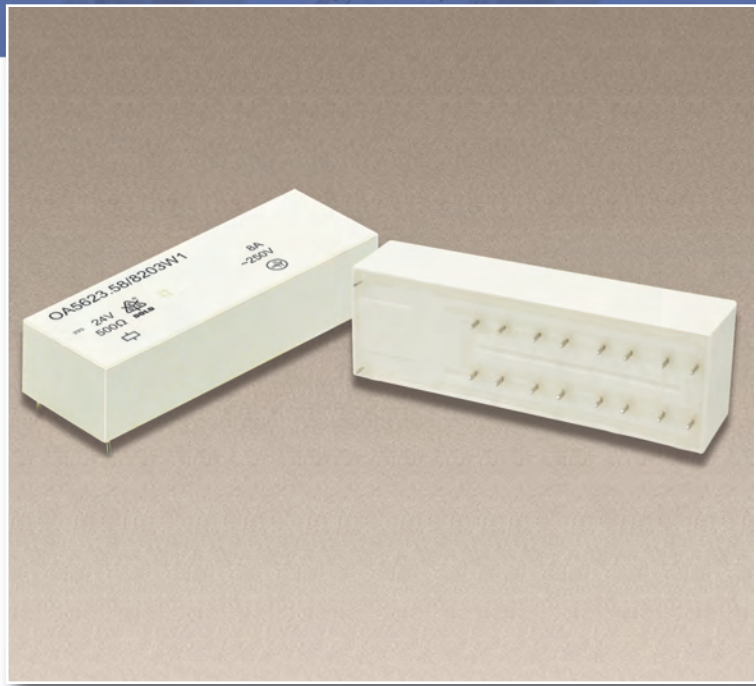

GERMANY

USA/CANADA  
E107778

### Technical Data

- **Nominal Coil Voltage** ..... 6, 12, 24, 48, 60, 110, DC
- **Coil Power Dissipation** ..... 1.2 W
- **Min./Max. Switching Voltage** ..... AC/DC10V / 250VDC, 400VAC<sup>1</sup>
- **Min./Max. Switching Current** ..... 10mA / 8 A (7 x 8A simultaneous)<sup>1</sup>
- **Min./Max. Switching Power – DC** ..... 0.1W / 200W<sup>1</sup>
- **Min./Max. Switching Power – AC** ..... 0.1VA / 2000VA<sup>1</sup>
- **Contact Switching Rate** ..... 10 operations per second
- **Relay Operate Time** ..... 16 ms
- **Relay Release Time** ..... 8 ms
- **Operation Vibration** ..... 0.35 mm Ampl. max  
@ 10...200Hz, 5g max
- **Contact Arrangements** ..... 4NO/4NC, 5NO/3NC, 6NO/2NC, 7NO/1NC
- **Contact Material** ..... AgNi10+0.2 $\mu$ mAu  
..... AgSnO<sub>2</sub>+0.2 $\mu$ mAu, AgNi10+5 $\mu$ mAu
- **Mechanical Life** ..... >20x10<sup>6</sup> operation cycles
- **Electrical Life** ..... AgNi10 >10<sup>5</sup> operation cycles  
..... @ 230V AC, 8A, cos  $\varphi$ =1
- **Ambient Temperature** ..... -40...+80°C
- **Cover Material** ..... Polyamide 6
- **Weight** ..... 40 g
- **Wave Solder Temperature/Duration** ..... 260°C/5s
- More detailed data upon request

### Diagrams

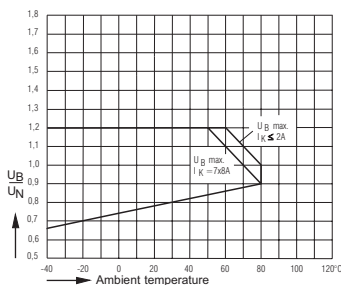

Relay operation voltage vs. ambient temperature

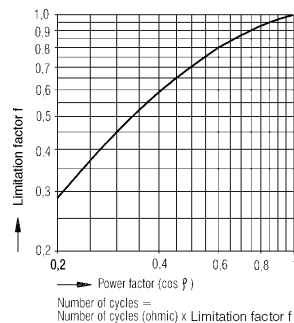

Limitation factor for inductive loads

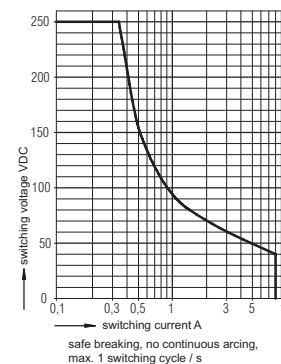

Maximum switching power curve

<sup>1</sup> AgNi10+5 $\mu$ mAu contact material has limited switching capacity (Min./Max. 2V/60VAC/DC, 2mA/0.3A, 10mVA/12VA, 10mW/12W)

## Relay Data

## Ordering Information

Rated Voltage	Voltage Range	Coil Resistance (10%)	4 NO/4 NC Type	5 NO/3 NC Type	6 NO/2 NC Type	7 NO/1 NC Type
6V	4.8 - 7.2V	31 Ω	56.OA23.0644 □	56.OA23.0653 □	56.OA23.0662 □	56.OA23.0671 □
12V	9.6 - 14.4V	120 Ω	56.OA23.1244 □	56.OA23.1253 □	56.OA23.1262 □	56.OA23.1271 □
24V	19.2 - 28.8V	500 Ω	56.OA23.2444 □	56.OA23.2453 □	56.OA23.2462 □	56.OA23.2471 □
48V	38.4 - 57.6V	2000 Ω	56.OA23.4844 □	56.OA23.4853 □	56.OA23.4862 □	56.OA23.4871 □
60V	48.0 - 72.0V	2880 Ω	56.OA23.6044 □	56.OA23.6053 □	56.OA23.6062 □	56.OA23.6071 □
110V	88.0 - 132.0V	10100 Ω	56.OA23.1144 □	56.OA23.1153 □	56.OA23.1162 □	56.OA23.1171 □

For S-Type:

Please specify **S** when ordering:

Example: 56.OA23S.\_\_\_\_□

Contact Material, Example: **C** AgSnO<sub>2</sub>+2μmAu

**N** AgNi10+2μmAu

**S** AgNi10+5μmAu

## Footprints (solder side)

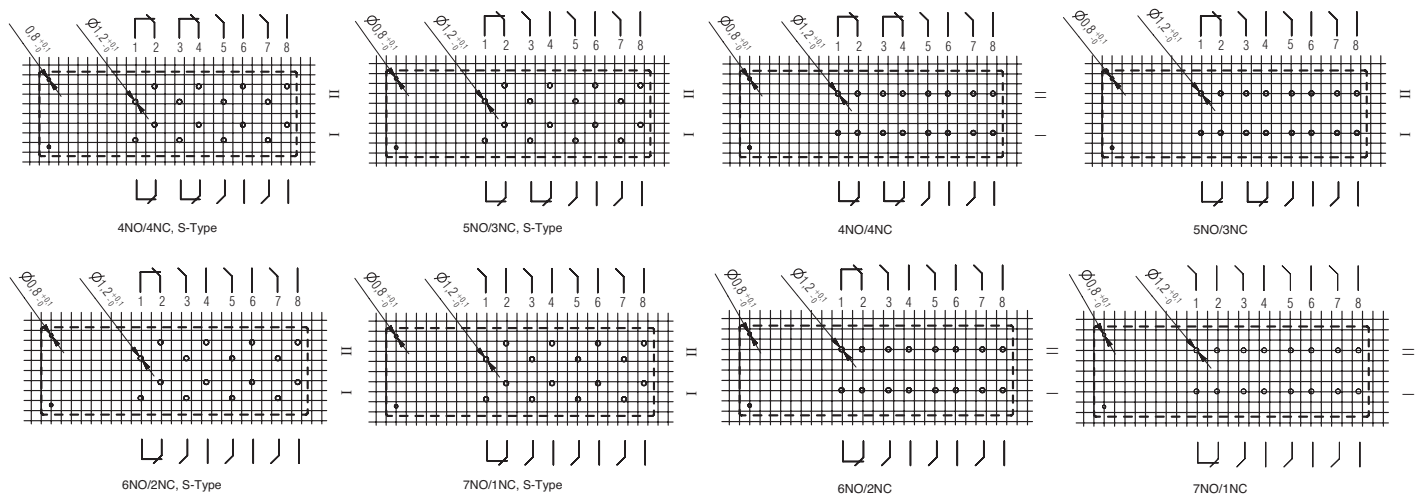

## Dimensions

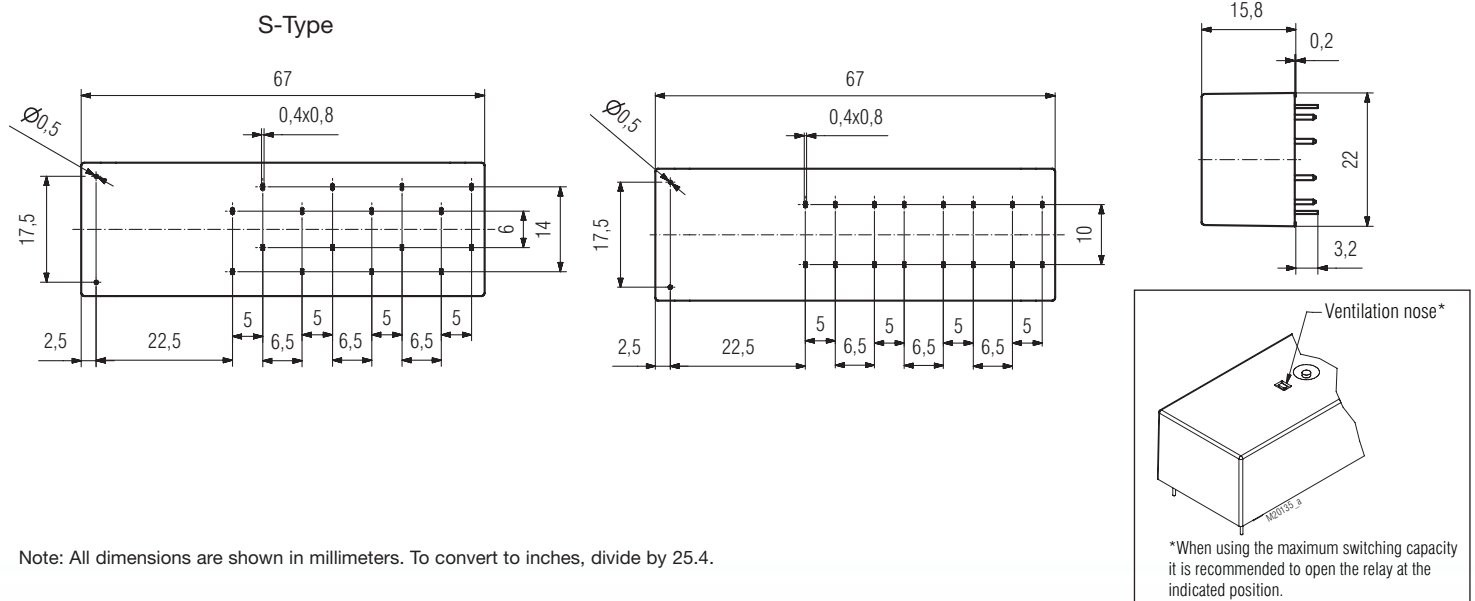

# Safety Relay OA 5667 / OA 5667S

## Features

- 2 output contacts
- International approvals: TÜV, UL, cUL
- Quality control check for each safety relay
- Forced-guided contacts, all gold flash plated
- Contact Gap > 0.5 mm throughout life of relay
- Various contact materials, mixed contact material optional
- High coil voltage range
- High breakdown Voltage:
  - contact/coil  $\geq$  4 KV
  - contact/contact  $\geq$  2.5 KV
  - contact/contact  $\geq$  4 KV; S-Type and INO/INC
- High Creeping Distance:
  - contact/coil > 8 mm
  - contact/contact > 4.5 mm; S-Type 8 mm
- Custom design available,
  - coil voltage
  - coil resistance
  - contact pressure
  - operate/release time
- Standard Pack: 24 piece sleeve or 240 piece case

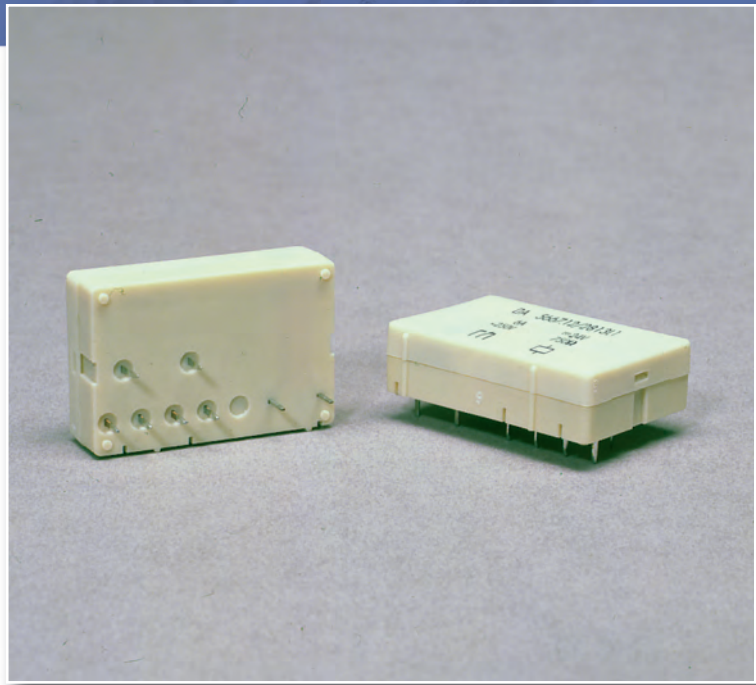

## Technical Data

- **Nominal Coil Voltage** .....6, 12, 24, 48, 60, 110 DC
- **Coil Power Dissipation** .....0.75 W
- **Min./Max. Switching Voltage** .....AC/DC10V / 250VDC, 400VAC<sup>1</sup>
- **Min./Max. Switching Current** .....10mA / 6A (2 x 6A simultaneous)<sup>1</sup>
- **Min./Max. Switching Power — DC** .....0.1W / 200W<sup>1</sup>
- **Min./Max. Switching Power — AC** .....0.1VA / 1500VA<sup>1</sup>
- **Contact Switching Rate** .....10 operations per second
- **Relay Operate Time** .....10 ms
- **Relay Release Time** .....6 ms
- **Operation Vibration** .....0.35 mm Ampl. max @ 10...100Hz, 4g max
- **Contact Arrangements** .....1 NO/1 NC, 2CO
- **Contact Material** .....AgNi10+0.2 $\mu$ mAu  
.....AgSnO<sub>2</sub>+0.2 $\mu$ mAu, AgNi10+5 $\mu$ mAu
- **Mechanical Life** ..... $\geq 10^7$  operation cycles
- **Electrical Life** .....AgSnO<sub>2</sub> >1.25x10<sup>5</sup>, AgNi10 >10<sup>5</sup>  
.....operation cycles @ 230V AC, 5A, cos  $\phi$ =1
- **Ambient Temperature** .....-40...+85°C
- **Protection Rating** .....RTII solder line proof
- **Cover Material** .....Thermoplastic
- **Weight** .....17 g
- **Wave Solder Temperature/Duration** .....260°C/5s
- More detailed data upon request

## Diagrams

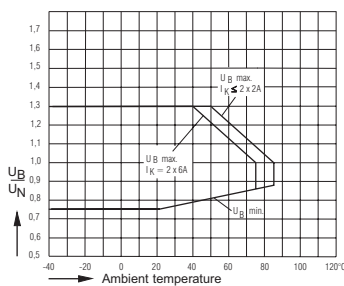

Relay operation voltage vs. ambient temperature

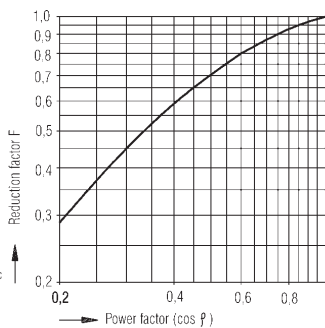

Limitation factor for inductive loads

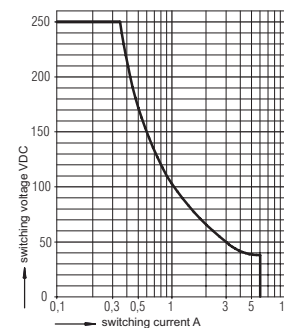

Maximum switching power curve

<sup>1</sup> AgNi10+5 $\mu$ mAu contact material has limited switching capacity (Min./Max. 2V/60VAC/DC, 2mA/0.3A, 10mVA/12VA, 10mW/12W)



### Relay Data

### Ordering Information

Rated Voltage	Voltage Range	Coil Resistance (10%)	1 NO/1 NC Type	2 CO Type	1 NO/1 NC S-Type	2 CO S-Type
6V	4.5 - 7.8V	48 Ω	56.OA67.0611□	56.OA67.0600□	56.OA67S.0611□	56.OA67S.0600□
12V	9.0 - 15.6V	183 Ω	56.OA67.1211□	56.OA67.1200□	56.OA67S.1211□	56.OA67S.1200□
24V	18.0 - 31.2V	750 Ω	56.OA67.2411□	56.OA67.2400□	56.OA67S.2411□	56.OA67S.2400□
48V	36.0 - 62.4V	3200 Ω	56.OA67.4811□	56.OA67.4800□	56.OA67S.4811□	56.OA67S.4800□
60V	45.0 - 78.0V	4700 Ω	56.OA67.6011□	56.OA67.6000□	56.OA67S.6011□	56.OA67S.6000□
110V	82.5 - 143.5V	15300 Ω	56.OA67.1111□	56.OA67.1100□	56.OA67S.1111□	56.OA67S.1100□

Contact Material, Example: **C**AgSnO<sub>2</sub>+2μmAu  
**N**AgNi10+.2μmAu  
**S**AgNi10+5μmAu

## Footprints (solder side)

2 CO

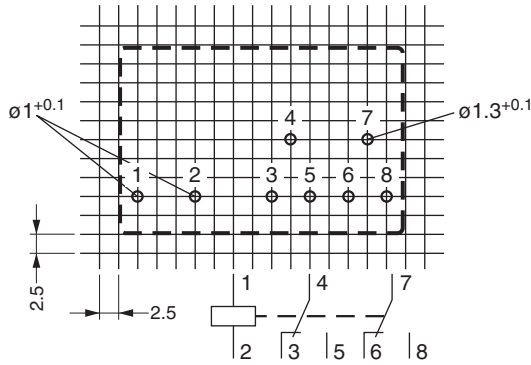

2 CO S-Type

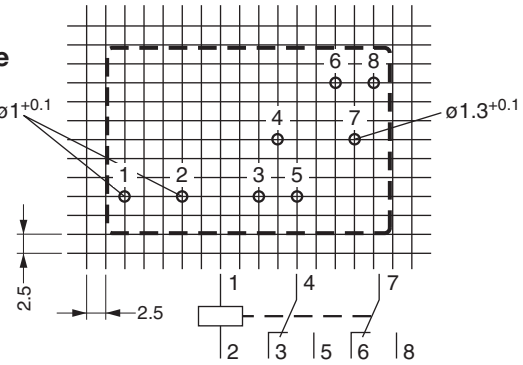

1 NO/1 NC

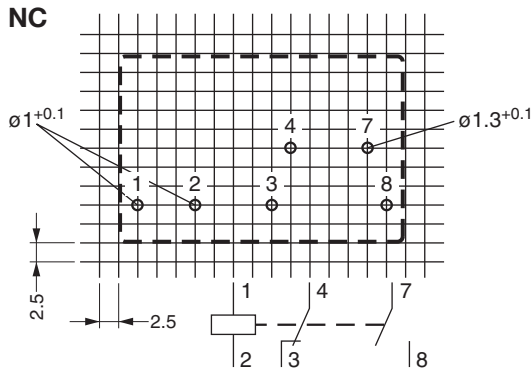

1 NO/1 NC S-Type

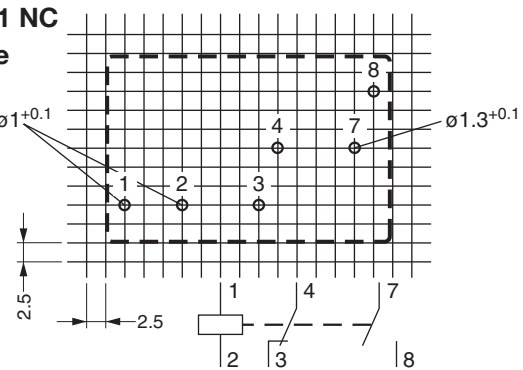

## Dimensions

2 CO

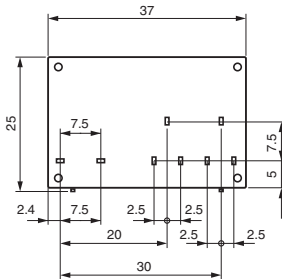

1 NO/1 NC

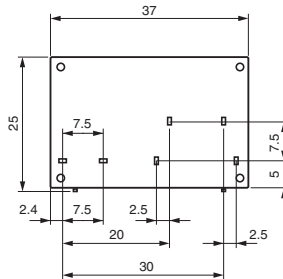

2 CO, S-Type

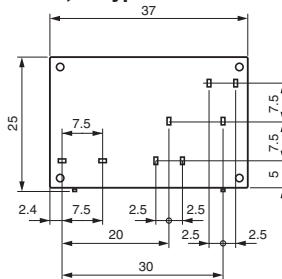

1 NO/1 NC, S-Type

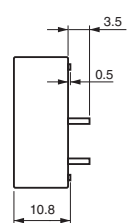
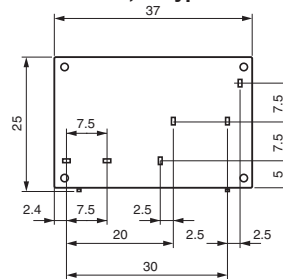

Note: All dimensions are shown in millimeters. To convert to inches, divide by 25.4.

# Safety Relay OA 5611

## Features

- 4 output contacts
- International approvals: TÜV, UL, cUL
- Quality control check for each safety relay
- Forced-guided contacts, all gold flash plated
- Contact Gap > 0.5 mm throughout life of relay
- Various contact materials, mixed contact material optional
- High coil voltage range
- High switching voltage
- High breakdown voltage: contact/coil  $\geq 4$  KV
- High creeping distance:
  - contact/contact  $\geq 2.5$  KV
  - contact/coil  $\geq 8$  mm
  - contact/contact  $\geq 4.5$  mm
- Crown contacts
- Solid connection between coil and contact housing
- Compact size
- Custom design available,
  - coil voltage
  - RTIII wash proof
  - contact pressure
  - coil resistance
  - operate/release time
  - low power dissipation models
  - Manual test relay (slide activated)
- Standard Pack: 30 piece sleeve or 150 piece case



GERMANY

USA/CANADA  
E146415

## Technical Data

- **Nominal Coil Voltage** .....6, 12, 24, 48, 60, 110, DC
- **Coil Power Dissipation** .....0.6 W
- **Min./Max. Switching Voltage** .....AC/DC10V / 250VDC, 400VAC<sup>1</sup>
- **Min./Max. Switching Current** .....10mA / 8 A (3 x 8A simultaneous)<sup>1</sup>
- **Min./Max. Switching Power – DC** .....0.1W / 200W<sup>1</sup>
- **Min./Max. Switching Power – AC** .....0.1VA / 2000VA<sup>1</sup>
- **Contact Switching Rate** .....10 operations per second
- **Relay Operate Time** .....20 ms
- **Relay Release Time** .....6 ms
- **Operation Vibration** .....0.35 mm Ampl. max  
@ 10...200Hz, 3g max
- **Protection Rating** .....RTIII solder line proof
- **Contact Arrangements** .....2NO/2NC, 3NO/1NC
- **Contact Material** .....  
...AgNi10+0.2 $\mu$ mAu, AgSnO<sub>2</sub>+0.2 $\mu$ mAu, AgNi10+5 $\mu$ mAu
- **Mechanical Life** ..... $\geq 50 \times 10^6$  operation cycles
- **Electrical Life** .....AgSnO<sub>2</sub> > 1.5 $\times 10^5$ , AgNi10 > 10<sup>5</sup>  
.....operation cycles @ 230V AC, 8A, cos  $\phi$ =1
- **Ambient Temperature** .....-40...+85°C
- **Cover Material** .....Thermoplastic
- **Weight** .....35 g
- **Wave Solder Temperature/Duration** .....260°C/5s
- More detailed data upon request

## Diagrams

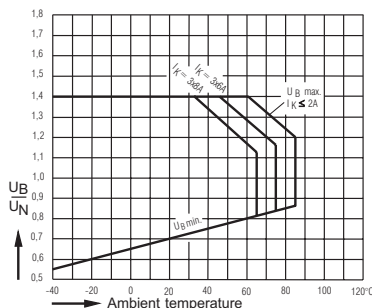

Relay operation voltage vs. ambient temperature

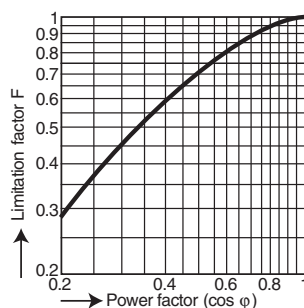

Operations =  
Operations (ohmic) x limitation factor F  
Limitation factor for inductive loads

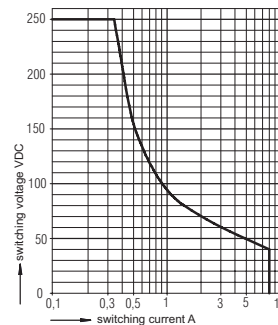

Maximum switching power curve

<sup>1</sup> AgNi10+5 $\mu$ mAu contact material has limited switching capacity (Min./Max. 2V/60VAC/DC, 2mA/0.3A, 10mVA/12VA, 10mW/12W)

### Relay Data

### Ordering Information

Rated Voltage	Voltage Range	Coil Resistance (10%)	2 NO/2 NC Type	3 NO/1 NC Type
6V	4.2 - 8.4V	56 Ω	56.OA11.0622□	56.OA11.0631□
12V	8.4 - 16.8V	240 Ω	56.OA11.1222□	56.OA11.1231□
24V	16.8 - 33.6V	960 Ω	56.OA11.2422□	56.OA11.2431□
48V	33.6 - 67.2V	3840 Ω	56.OA11.4822□	56.OA11.4831□
60V	42.0 - 84.0V	6000 Ω	56.OA11.6022□	56.OA11.6031□
110V	77.0 - 154.0V	20150 Ω	56.OA11.1122□	56.OA11.1131□

Contact Material, Example: CAgSnO<sub>2</sub>+2μmAu  
NAgNi10+.2μmAu  
SAgNi10+5μmAu

### Footprints (solder side)

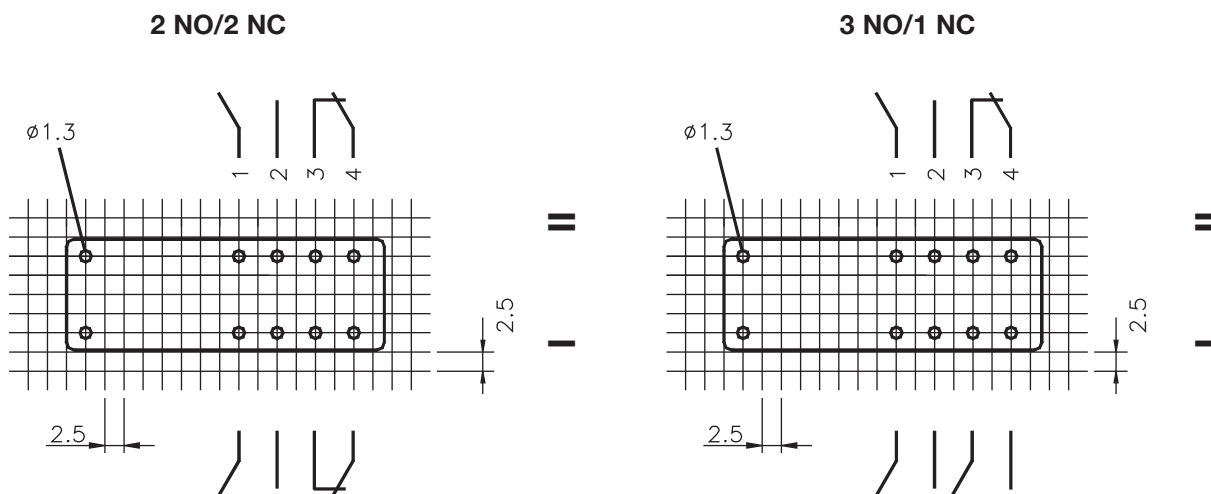

### Dimensions

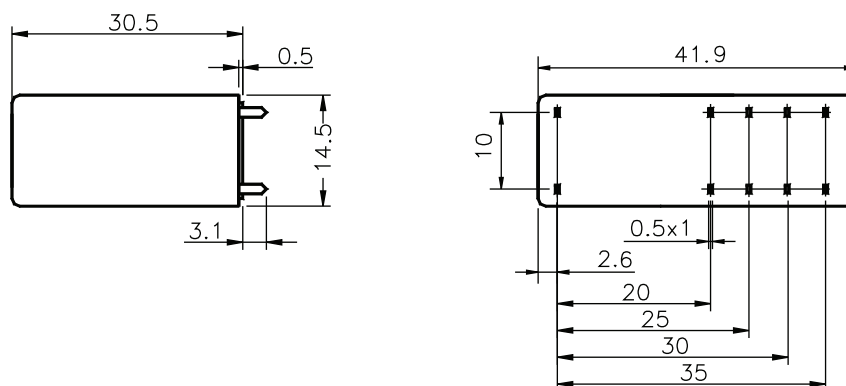

Note: All dimensions are shown in millimeters. To convert to inches, divide by 25.4.

# Safety Relay OA 5612

## Features

- 6 output contacts
- International approvals: TÜV, UL, cUL
- Quality control check for each safety relay
- Forced-guided contacts, all gold flash plated
- Contact Gap > 0.5 mm throughout life of relay
- Various contact materials, mixed contact material optional
- High coil voltage range
- Very high switching voltage
- High breakdown voltage: contact/coil  $\geq 4$  KV  
contact/contact  $\geq 2.5$  KV
- High creeping distance: contact/coil  $\geq 8$  mm  
contact/contact  $\geq 4.5$  mm
- Crown contacts
- Solid connection between coil and contact housing
- Compact size
- Custom design available,
  - coil voltage RTIII wash proof
  - contact pressure -coil resistance
  - operate/release time
  - low power dissipation models
- Standard Pack: 20 piece sleeve or 100 piece case



GERMANY

USA/CANADA  
E146415

## Technical Data

- **Nominal Coil Voltage** .....6, 12, 24, 48, 60, 110, DC
- **Coil Power Dissipation** .....0.8 - 1.0 W\*
- **Min./Max. Switching Voltage** .....AC/DC10V / 250VDC, 400VAC<sup>1</sup>
- **Min./Max. Switching Current** .....10mA / 8 A (5 x 8A simultaneous)<sup>1</sup>
- **Min./Max. Switching Power—DC** .....0.1W / 200W<sup>1</sup>
- **Min./Max. Switching Power—AC** .....0.1VA / 2000VA<sup>1</sup>
- **Contact Switching Rate** .....10 operations per second
- **Relay Operate Time** .....20 ms
- **Relay Release Time** .....6 ms
- **Operation Vibration** .....0.35 mm Ampl. max  
@ 10...200Hz, 3g max
- **Protection Rating** .....RTII solder line proof
- **Contact Arrangements** .....2NO/4NC\*, 3NO/3NC, 4NO/2NC
- **Contact Material** .....AgNi10+0.2 $\mu$ mAu, AgSnO<sub>2</sub>+0.2 $\mu$ mAu, AgNi10+5 $\mu$ mAu
- **Mechanical Life** ..... $\geq 50 \times 10^6$  operation cycles
- **Electrical Life** .....AgSnO<sub>2</sub> >1.5 $\times 10^5$ , AgNi10 >10<sup>5</sup>  
operation cycles @ 230V AC, 8A, cos  $\phi$ =1
- **Ambient Temperature** .....-40...+85°C
- **Cover Material** .....Thermoplastic
- **Weight** .....38 g
- **Wave Solder Temperature/Duration** .....260°C/5s
- More detailed data upon request

## Diagrams

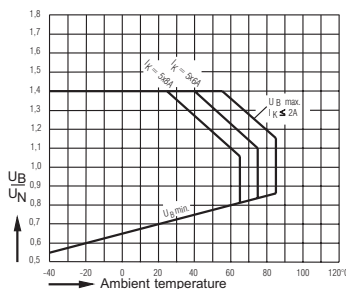

Relay operation voltage vs. ambient temperature

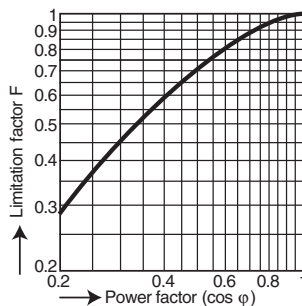

Limitation factor for inductive loads  
Operations = Operations (ohmic) x limitation factor F

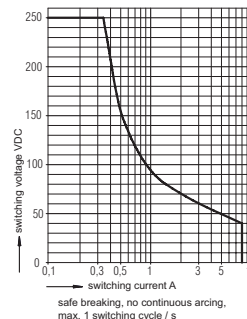

Maximum switching power curve  
Limit curve for arc-free operation  
safe breaking, no continuous arcing, max. 1 switching cycle / s

<sup>1</sup> AgNi10+5 $\mu$ mAu contact material has limited switching capacity (Min./Max. 2V/60VAC/DC, 2mA/0.3A, 10mVA/12VA, 10mW/12W)

### Relay Data

### Ordering Information

Rated Voltage	Voltage Range	Coil Resistance (10%)	2 NO/4 NC Type	Coil Resistance (10%)	3 NO/3 NC Type	4 NO/2 NC Type
6V	4.2 - 8.4V	36 Ω	56.OA12.0624□	45 Ω	56.OA12.0633□	56.OA12.0642□
12V	8.4 - 16.8V	145 Ω	56.OA12.1224□	180 Ω	56.OA12.1233□	56.OA12.1242□
24V	16.8 - 33.6V	600 Ω	56.OA12.2424□	720 Ω	56.OA12.2433□	56.OA12.2442□
48V	33.6 - 67.2V	2300 Ω	56.OA12.4824□	2880 Ω	56.OA12.4833□	56.OA12.4842□
60V	42.0 - 84.0V	3600 Ω	56.OA12.6024□	4500 Ω	56.OA12.6033□	56.OA12.6042□
110V	77.0 - 154.0V	12100 Ω	56.OA12.1124□	15125 Ω	56.OA12.1133□	56.OA12.1142□

Contact Material, Example: C AgSnO<sub>2</sub>+2μmAu  
N AgNi10+.2μmAu  
S AgNi10+5μmAu

### Footprints (solder side)

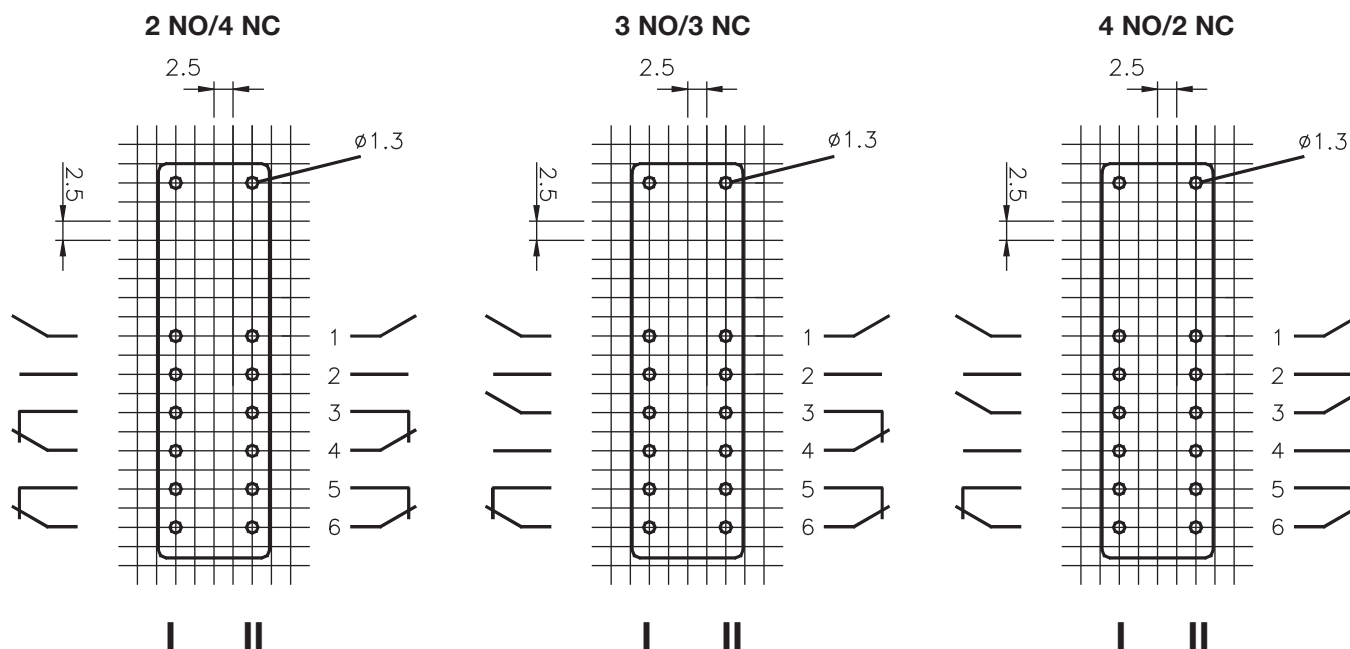

### Dimensions

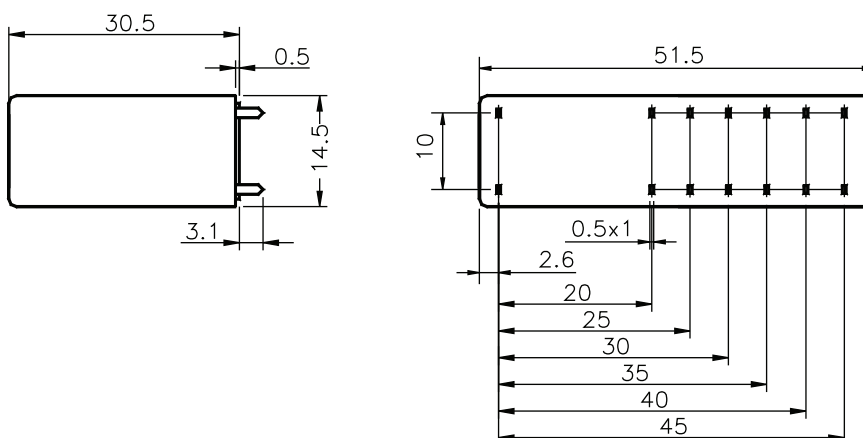

Note: All dimensions are shown in millimeters. To convert to inches, divide by 25.4.

# Safety Relay OA 5601

## Features

- 4 output contacts
- International approvals:  
TÜV, UL, cUL
- Quality control check for each safety relay
- Forced-guided contacts, all gold flash plated
- Contact gap > 0.5 mm throughout life of relay
- Various contact materials,  
mixed contact material optional
- High coil voltage range
- High switching voltage
- High breakdown voltage: contact/coil  $\geq 4$  KV
- High creeping distance: contact/contact  $\geq 4$  KV  
contact/coil  $\geq 8$  mm  
contact/contact  $\geq 5.5$  mm
- Crown contacts
- Solid connection between coil and contact housing
- Custom design available,  
-coil voltage                      -coil resistance  
-contact pressure                -operate/release time  
-RTIII wash proof
- Standard Pack: 20 piece sleeve or 100 piece case



GERMANY

USA/CANADA  
E146415

## Technical Data

- **Nominal Coil Voltage** .....6,12 ,24, 48, 60, 110, DC
- **Coil Power Dissipation** .....0.75 W
- **Min./Max. Switching Voltage** .....AC/DC10V / 250VDC, 400VAC<sup>1</sup>
- **Min./Max. Switching Current** .....10mA / 10 A (3 x 10A simultaneous)<sup>1</sup>
- **Min./Max. Switching Power—DC** .....0.1W / 240W<sup>1</sup>
- **Min./Max. Switching Power—AC** .....0.1VA / 2500VA<sup>1</sup>
- **Contact Switching Rate** .....10 operations per second
- **Relay Operate Time** .....27 ms
- **Relay Release Time** .....5 ms
- **Operation Vibration** .....0.35 mm Ampl. max  
.....@ 10...55Hz, 5g max
- **Contact Arrangements** .....2NO/2NC, 3NO/1NC
- **Contact Material** .....AgSnO<sub>2</sub>+0.2μmAu, AgNi10+0.2μmAu, AgNi10+5μmAu
- **Mechanical Life** .....>30x10<sup>6</sup> operation cycles
- **Electrical Life** .....AgSnO<sub>2</sub> >5x10<sup>5</sup>, AgNi10 >4x10<sup>5</sup>  
.....operation cycles @ 230V AC, 10A, cos φ=1
- **Ambient Temperature** .....-40...+85°C
- **Protection Rating** .....RTII solder line proof
- **Cover Material** .....Thermoplastic
- **Weight** .....78 g
- **Wave Solder Temperature/Duration** .....260°C/5s
- More detailed data upon request

## Diagrams

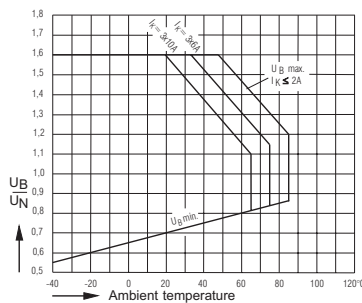

Relay operation voltage vs. ambient temperature

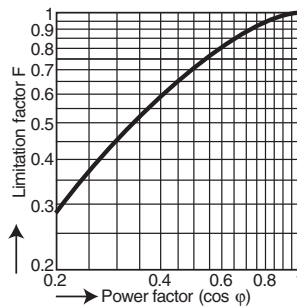

Operations =  
Operations (ohmic) x limitation factor F

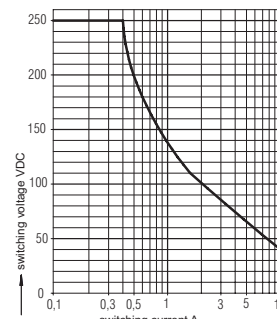

Maximum switching power curve

<sup>1</sup> AgNi10+5μmAu contact material has limited switching capacity (Min./Max. 2V/60VAC/DC, 2mA/0.3A, 10mVA/12VA, 10mW/12W)

### Relay Data

### Ordering Information

Rated Voltage	Voltage Range	Coil Resistance (10%)	2 NO/2 NC Type	3 NO/1 NC Type
6V	4.2 - 9.6V	48 Ω	56.OA01.0622□	56.OA01.0631□
12V	8.4 - 19.2V	192 Ω	56.OA01.1222□	56.OA01.1231□
24V	16.8 - 38.4V	770 Ω	56.OA01.2422□	56.OA01.2431□
48V	33.6 - 76.8V	2880 Ω	56.OA01.4822□	56.OA01.4831□
60V	42.0 - 96.0V	4800 Ω	56.OA01.6022□	56.OA01.6031□
110V	77.0 - 176.0V	16000 Ω	56.OA01.1122□	56.OA01.1131□

Contact Material, Example:  AgSnO<sub>2</sub>+0.2μmAu

AgNi10+0.2μmAu

AgNi10+5μmAu

## Footprints (solder side)

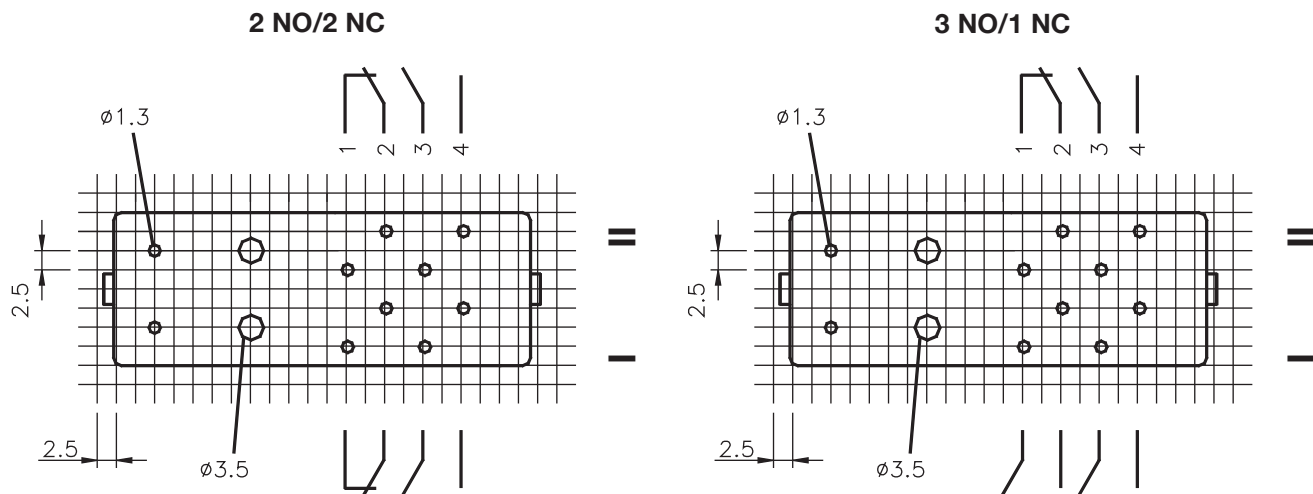

## Dimensions

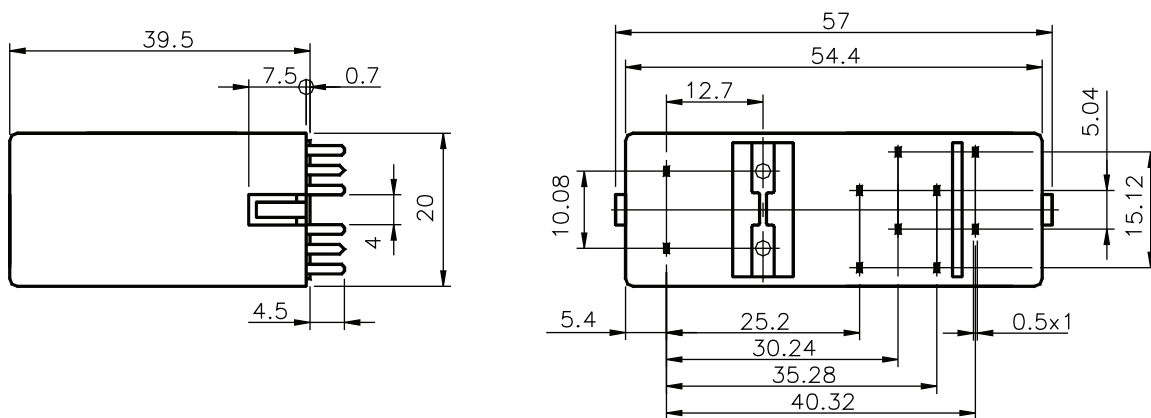

Note: All dimensions are shown in millimeters. To convert to inches, divide by 25.4.

# Safety Relay OA 5602

## Features

- 6 output contacts
- International approvals: TÜV, UL, cUL
- Quality control check for each safety relay
- Forced-guided contacts, all gold flash plated
- Contact gap > 0.5 mm throughout life of relay
- Various contact materials, mixed contact material optional
- High coil voltage range
- High switching voltage
- High breakdown voltage: contact/coil  $\geq$  4 kV
- High creeping distance: contact/coil  $\geq$  8 mm  
contact/contact  $\geq$  5.5 mm
- Crown contacts
- Solid connection between coil and contact housing
- Custom coil voltage available
- Custom design available,
  - coil voltage
  - coil resistance
  - contact pressure
  - operate/release time
  - RTIII wash proof
- Standard Pack: 15 piece sleeve or 75 piece case



GERMANY



USA/CANADA  
E146415

## Technical Data

- **Nominal Coil Voltage** .....6, 12, 24, 48, 60, 110, DC
- **Coil Power Dissipation** .....1.0 W
- **Min./Max. Switching Voltage** .....AC/DC10V / 250VDC, 400VAC<sup>1</sup>
- **Min./Max. Switching Current** .....10mA / 10 A (4 x 10A simultaneous)<sup>1</sup>
- **Min./Max. Switching Power—DC** .....0.1W / 240W<sup>1</sup>
- **Min./Max. Switching Power—AC** .....0.1VA / 2500VA<sup>1</sup>
- **Contact Switching Rate** .....10 operations per second
- **Relay Operate Time** .....27 ms
- **Relay Release Time** .....5 ms
- **Operation Vibration** .....0.35 mm Ampl. max @ 10...55Hz, 5g max
- **Protection Rating** .....RTII solder line proof
- **Contact Arrangements** .....2NO/4NC, 3NO/3NC, 4NO/2NC
- **Contact Material** .....AgSnO<sub>2</sub>+0.2µmAu, AgNi10+0.2µmAu, AgNi10+5µmAu
- **Mechanical Life** .....>30x10<sup>6</sup> Operation cycles
- **Electrical Life** .....AgSnO<sub>2</sub> >5x10<sup>5</sup>, AgNi10 >4x10<sup>5</sup> operation cycles @ 230V AC, 10A, cos φ=1
- **Ambient Temperature** .....-40...+85°C
- **Cover Material** .....Thermoplastic
- **Weight** .....85 g
- **Wave Solder Temperature/Duration** .....260°C/5s
- More detailed data upon request

## Diagrams

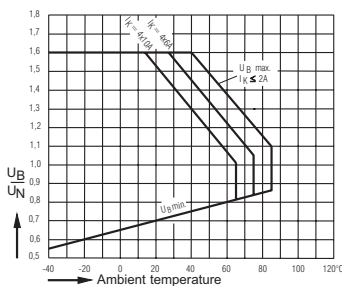

Relay operation voltage vs. ambient temperature

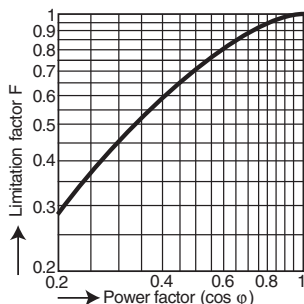

Limitation factor for inductive loads  
Operations = Operations (ohmic) x limitation factor F

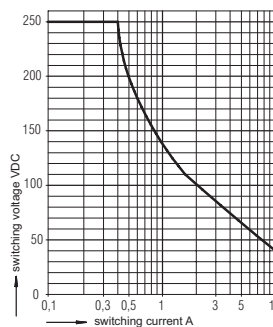

Maximum switching power curve  
safe breaking, no continuous arcing, max. 1 switching cycle / s

<sup>1</sup> AgNi10+5µmAu contact material has limited switching capacity (Min./Max. 2V/60VAC/DC, 2mA/0.3A, 10mVA/12VA, 10mW/12W)



### Relay Data

### Ordering Information

Rated Voltage	Voltage Range	Coil Resistance (10%)	2 NO/4 NC Type	3 NO/3 NC Type	4 NO/2 NC Type
6V	4.2 - 9.6V	35 Ω	56.OA02.0624□	56.OA02.0633□	56.OA02.0642□
12V	8.4 - 19.2V	140 Ω	56.OA02.1224□	56.OA02.1233□	56.OA02.1242□
24V	16.8 - 38.4V	570 Ω	56.OA02.2424□	56.OA02.2433□	56.OA02.2442□
48V	33.6 - 76.8V	2300 Ω	56.OA02.4824□	56.OA02.4833□	56.OA02.4842□
60V	42.0 - 96.0V	3600 Ω	56.OA02.6024□	56.OA02.6033□	56.OA02.6042□
110V	77.0 - 176.0V	12100 Ω	56.OA02.1124□	56.OA02.1133□	56.OA02.1142□

Contact Material, Example: □ AgSnO<sub>2</sub>+2μmAu

□ AgNi10+.2μmAu

□ AgNi10+5μmAu

### Footprints (solder side)

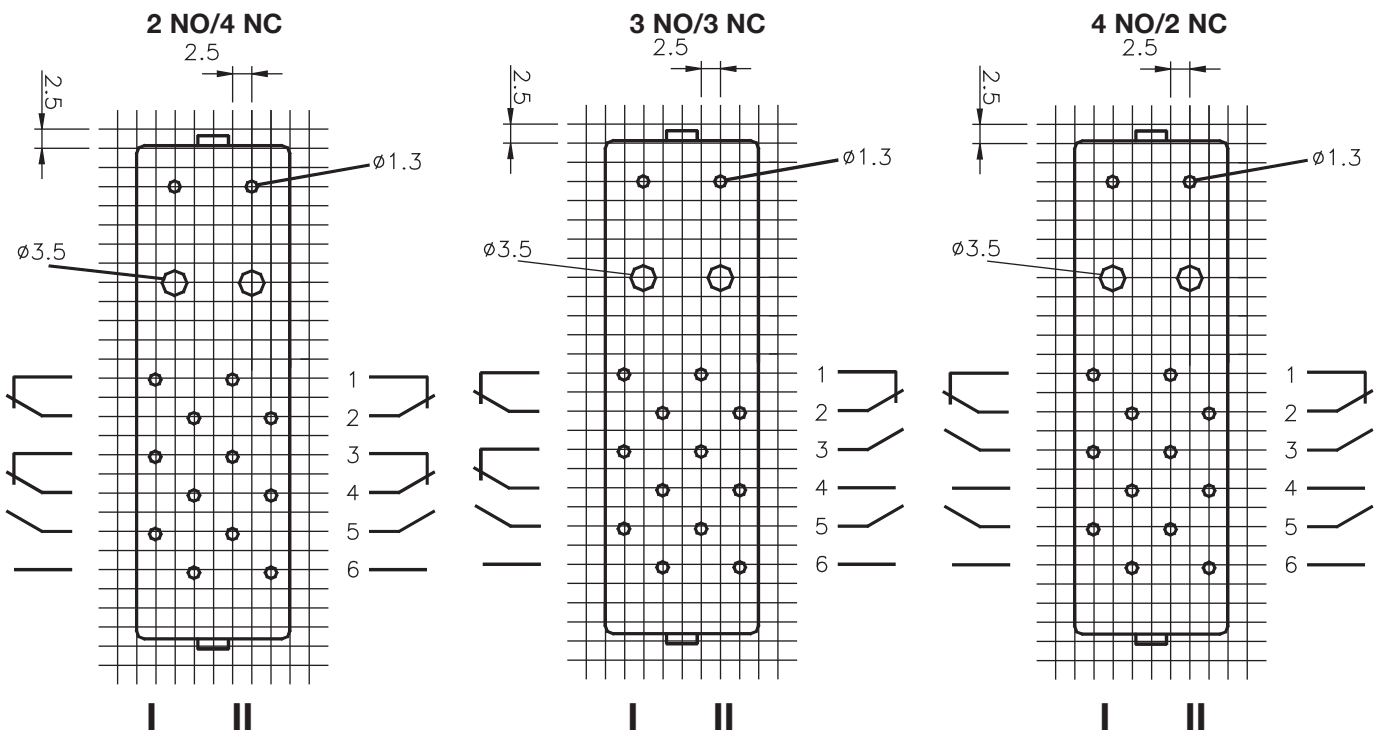

### Dimensions

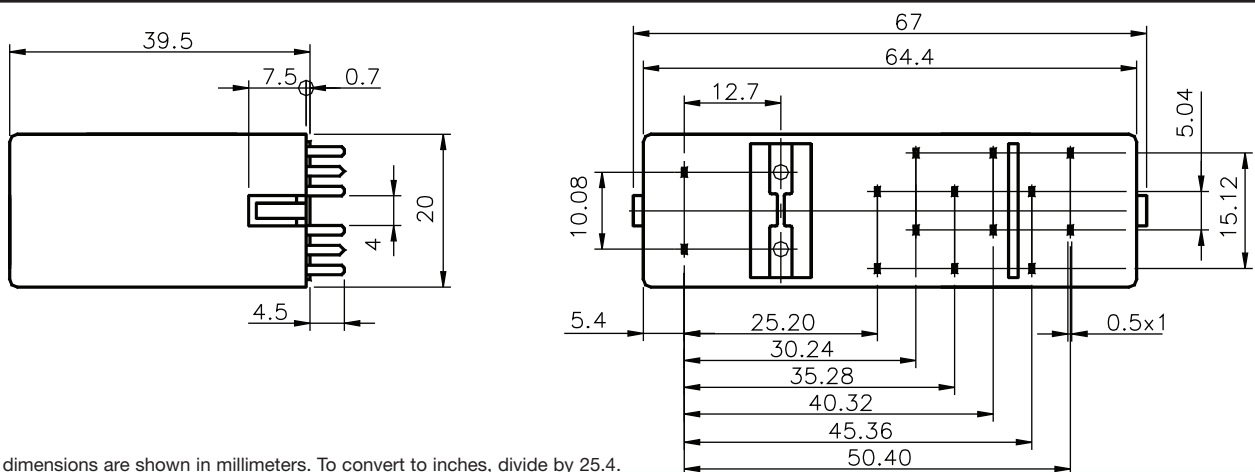

Note: All dimensions are shown in millimeters. To convert to inches, divide by 25.4.

# Safety Relay OA 5603

## Features

- 8 output contacts
- International approvals: TÜV, UL, cUL
- Quality control check for each safety relay
- Forced-guided contacts, all gold flash plated
- Contact gap > 0.5 mm throughout life of relay
- Various contact materials, mixed contact material optional
- High coil voltage range
- High switching voltage
- High breakdown voltage: contact/coil  $\geq$  4 KV  
contact/contact  $\geq$  4KV
- High creeping distance: contact/coil  $\geq$  8 mm  
contact/contact  $\geq$  5.5 mm
- Crown contacts
- Solid connection between coil and contact housing
- Custom design available,
  - coil voltage
  - coil resistance
  - contact pressure
  - operate/release time
  - RTIII wash proof
- Standard Pack: 15 piece sleeve or 75 piece case



## Technical Data

- **Nominal Coil Voltage** 6, 12, 24, 48, 60, 110, DC
- **Coil Power Dissipation** .....1.25 - 1.65 W\*
- **Min./Max. Switching Voltage**.....AC/DC10V / 250VDC, 400VAC<sup>1</sup>
- **Min./Max. Switching Current**.....10mA / 10 A (6 x 10A simultaneous)<sup>1</sup>
- **Min./Max. Switching Power—DC** .....0.1W / 240W<sup>1</sup>
- **Min./Max. Switching Power—AC** .....0.1VA / 2500VA<sup>1</sup>
- **Contact Switching Rate** .....10 operations per second
- **Relay Operate Time**.....27 ms
- **Relay Release Time**.....5 ms
- **Operation Vibration** .....0.35 mm Ampl. max  
.....@ 10...55Hz, 5g max
- **Protection Rating**.....RTII solder line proof
- **Contact Arrangements** .....2NO/6NC\*, 3NO/5NC\*, 4NO/4NC, 5NO/3NC,  
.....6NO/2NC, 7NO/1NC
- **Contact Material**.....AgSnO<sub>2</sub>+0.2µmAu, AgNi10+0.2µmAu, AgNi10+5µmAu
- **Mechanical Life**.....>30x10<sup>6</sup> Operation cycles
- **Electrical Life** .....AgSnO<sub>2</sub> >5x10<sup>5</sup>, AgNi10 >4x10<sup>5</sup>  
.....operation cycles @ 230V AC, 10A, cos φ=1
- **Ambient Temperature** .....-40...+75°C
- **Cover Material**.....Thermoplastic
- **Weight**.....95 g
- **Wave Solder Temperature/Duration** .....260°C/5s
- More detailed data upon request

## Diagrams

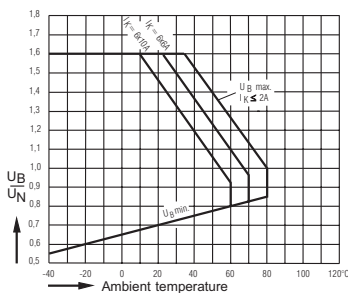

Relay operation voltage vs. ambient temperature

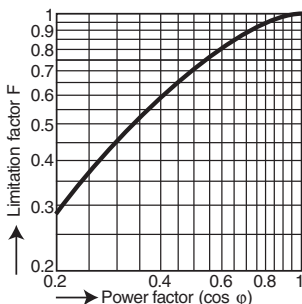

Operations =  
Operations (ohmic) x limitation factor F  
Limitation factor for inductive loads

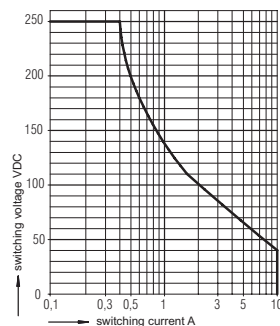

Maximum switching power curve

<sup>1</sup> AgNi10+5µmAu contact material has limited switching capacity (Min./Max. 2V/60VAC/DC, 2mA/0.3A, 10mVA/12VA, 10mW/12W)

### Relay Data

### Ordering Information

Rated Voltage	Voltage Range	Coil Resistance (10%)	2 NO/6 NC Type	3 NO / 5 NC Type	Coil Resistance (10%)	4 NO / 4 NC Type	5 NO / 3 NC Type	6 NO / 2 NC Type	7 NO / 1 NC Type
6V	4.2 - 9.6V	21 Ω	56.OA03.0626□	56.OA03.0635□	29 Ω	56.OA03.0644□	56.OA03.0653□	56.OA03.0662□	56.OA03.0671□
12V	8.4 - 19.2V	88 Ω	56.OA03.1226□	56.OA03.1235□	112 Ω	56.OA03.1244□	56.OA03.1253□	56.OA03.1262□	56.OA03.1271□
24V	16.8 - 38.4V	370 Ω	56.OA03.2426□	56.OA03.2435□	460 Ω	56.OA03.2444□	56.OA03.2453□	56.OA03.2462□	56.OA03.2471□
48V	33.6 - 76.8V	1400 Ω	56.OA03.4826□	56.OA03.4835□	1800 Ω	56.OA03.4844□	56.OA03.4853□	56.OA03.4862□	56.OA03.4871□
60V	42.0 - 96.0V	2230 Ω	56.OA03.6026□	56.OA03.6035□	2880 Ω	56.OA03.6044□	56.OA03.6053□	56.OA03.6062□	56.OA03.6071□
110V	77.0 - 176.0V	7150 Ω	56.OA03.1126□	56.OA03.1135□	9500 Ω	56.OA03.1144□	56.OA03.1153□	56.OA03.1162□	56.OA03.1171□

Contact Material, Example: □ AgSnO<sub>2</sub>+2μmAu

□ AgNi10+2μmAu

□ AgNi10+5μmAu

### Footprints (solder side)

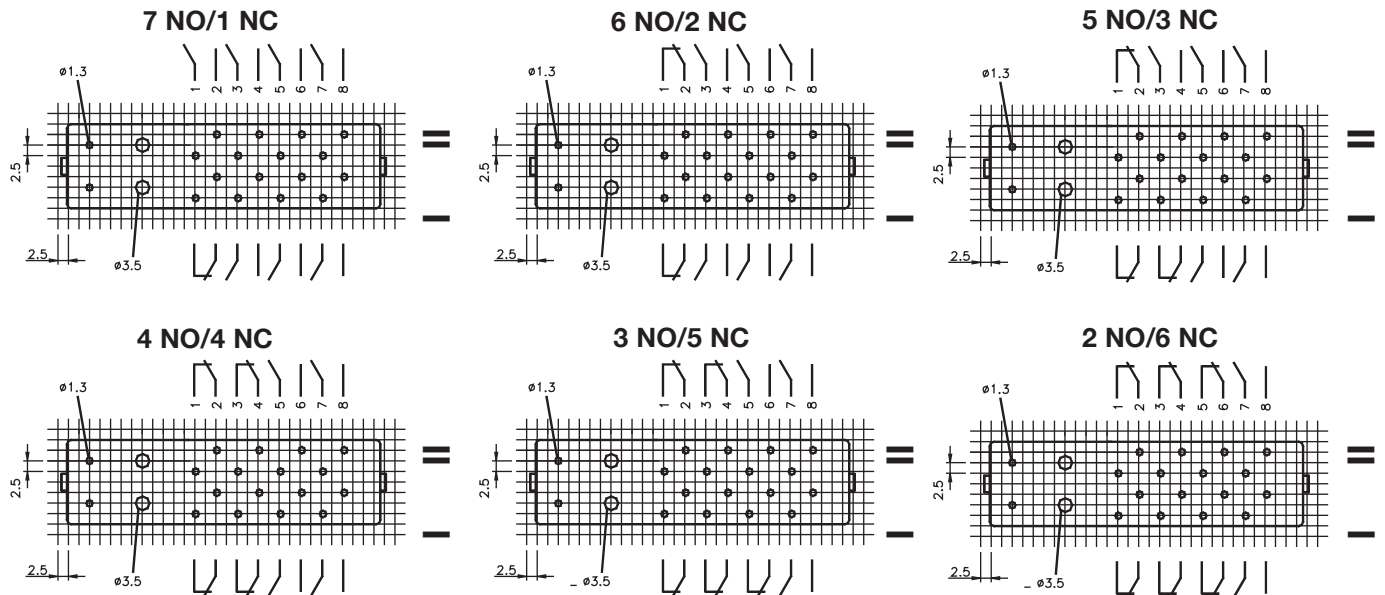

### Dimensions

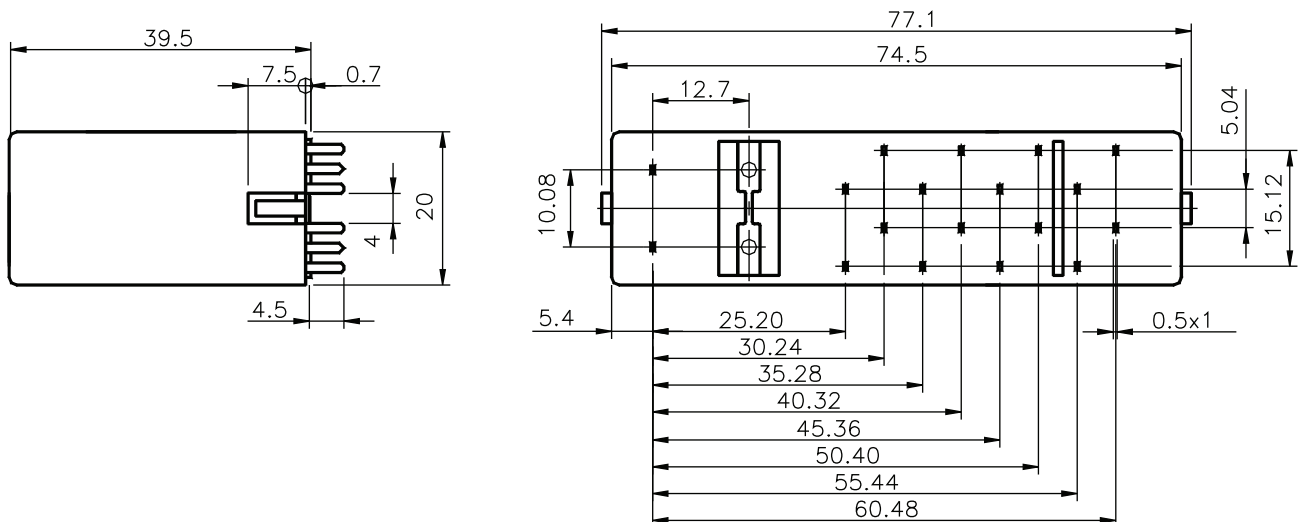

Note: All dimensions are shown in millimeters. To convert to inches, divide by 25.4.

# Altech® stocks a large quality line of DIN Enclosures

Build or maintain your competitive edge in the world markets. Enhance the value of your products and devices by packaging them attractively with enclosures from Altech. Applications are limitless. Our compact DIN enclosures are ideal for housing electrical, electronic and electromechanical devices including relays, sensing and monitoring devices, timers, transducers, printed circuit boards and more.

Altech's line of DIN Enclosures are manufactured by **DOLD**, a company well known in Europe for its quality DIN Enclosures and Safety Relays. They offer the most comprehensive selection of DIN enclosures available. These versatile housings are economical, easy to assemble and install. They provide protection and integral, ready-to-wire terminals in one attractive package. All at a level of quality that meets or exceeds national and international standards for performance and safety.

Wide Range of Sizes and Designs, Choice of Cover Styles, Terminal-To-Board Connection Options and 35mm DIN Rail or Panel Mount. Only flame retardant, maintenance free materials are used for safety, and to insure that your control devices look good for many years to come.

Customizing is easy. We can cut special holes and cutouts for operating, setting or indicating components that you may wish to install into the front panel. Terminals can be marked for quick identification and efficient field wiring. Instructions and custom markings can be imprinted. Our enclosures can even be molded in custom colors and custom configurations (OEM quantities). Whatever your requirements may be, we will do our best to help you meet them.

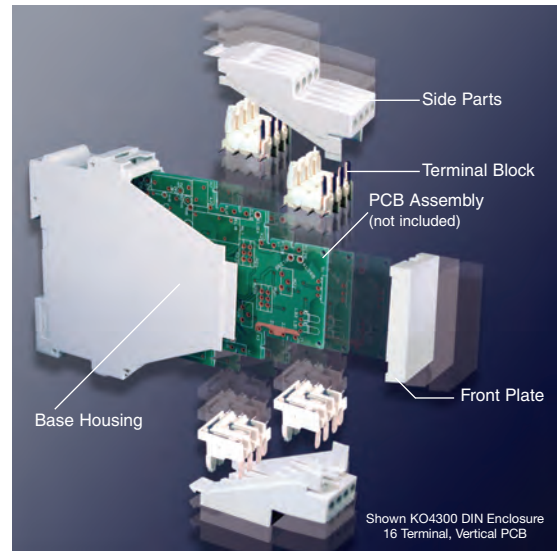

## KO4700

The KO4700 series offer a wide range of sizes with single and double level terminal configurations. They can be used for a wide range of applications. Complete with 8 to 132 terminals, select from pressure plate or box clamp terminations with fixed or pluggable terminal-to-board connections. Several cover designs add to the versatility of this series.

- DIN Rail or Panel Mount
- Fixed and Pluggable Designs
- Snap-On Keyed Covers
- Integral PC Board Guides
- Standard Color: Black Housing Shell with Tan Cover
- Modular Terminal Enclosures



## KS4400

The KS4400 series is simple, modular and flexible yet highly functional. The half shell design is cost effective and provides exceptional space utilization. Three levels of terminals with fixed and pluggable PCB terminal options allow for high density connections. A large front face area provides ample space for operator, communication and visual display components.

- DIN Rail Mount
- Fixed and Pluggable Terminals
- High Density Terminal Configuration
- Compact, Snap-together
- Standard Color: Black Housing with Gray Front Plate



Application Example



## K70

K70 series enclosures include a range of small to medium size DIN enclosures, complete with 8 to 32 terminals. They offer cost effective solutions for many applications. The K70s are supplied with integral pressure plate terminals for reliable connections. Terminal-to-board connections include fixed and pluggable solutions.

- DIN Rail or Panel Mount
- Integral PC Board Guides
- Snap-On Covers
- Fixed and Pluggable Designs
- Standard Color: Light Gray

## KU4000

The versatile KU4000 series enclosures feature generous internal space for printed circuit boards and electronic components. High density, double level snap-in terminals are of the pressure plate or spring cage design for gastight, vibration proof connections. Straight or angled solder pins offer flexibility in board layout. All versions have machine solderable terminals. KU4000 housings fit into standard 45mm (1.77 in.) high international style cutouts.

- DIN Rail or Panel Mount
- Integral PC Board Guides
- Front Fits 45mm (1.77 in.) Cutouts
- Terminal Cover Plugs Available
- Standard Color: Light Gray



## KU4100

The versatile KU4100 series features a compact design with different terminal configuration options. They are available in six widths with double level terminal locations. Terminal configuration options include blank enclosures with no terminal openings, fixed PCB terminals and pluggable PCB terminals.

- DIN Rail Mount
- Front Fits 45mm (1.77 in.) Cutouts
- Integral PC Board Guides
- Fixed and Pluggable Terminals
- Standard Color: Light Gray Cover with Black Base

## KO4300

The KO4300 series offers new design styling and cost effectiveness in a high density compact package. The double level terminals offer space savings while providing gas-tight, vibration proof connections. The enclosures are available with 16 to 64 terminals in 22.5 to 90 mm widths.

- DIN Rail Mount
- Machine Solderable Pins
- Integral PC Board Guides
- Compact High Density Design
- Standard Color: Light Gray



## KO4070

Compact, cost effective enclosures are ideal for I/O circuits, relays, timers and other small control devices. The KO4070 series enclosures are available in three widths with single and multi-level terminals. They are supplied complete with 4 to 16 box clamp type terminals that are machine solderable.

- DIN Rail Mount
- Machine Solderable Terminals
- Compact, Snap-Together
- Integral PC Board Guides
- Standard Color: Light Gray

Visit [altechcorp.com/dinenclosures](http://altechcorp.com/dinenclosures) for specification pages.

# Safety Relay Modules

## Isolated Channels - 8 Amp Contacts, 35 or 32 DIN Rail

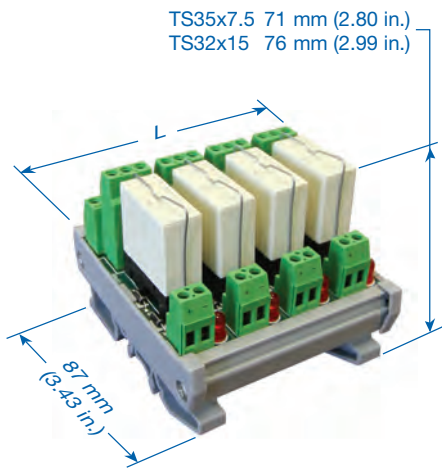

### Isolated Channel (Double Pole Double Throw)

Altech Safety Relay Modules utilize Relays with Force-Guided-Contacts that meet or exceed international standards, TÜV and UL. They are designed to protect man and machine as specified in OSHA FR1910 Regulations, a mandatory requirement of the European Machinery Directive EMD 89.392 EEC. The Safety Relays are used in Safety Devices such as Emergency Stop Modules, Safety Gate Monitors, 2-Hand Safety Modules, etc.

This series of Safety Relay Modules are Double Pole, Double Throw configurations, and are available as 1, 2, 4, 8 and 16 isolated channels and 8 and 16 bussed channels with 12 or 24 VDC coils. Isolated channels allow control of each relay by a different logic system, if necessary. There are two inputs for each relay coil per channel. Bussed channels allow high density packaging with a common input for all relays. Safety Relay Modules may be ordered with three different types of relay contact material, depending on the actual load current.

- Screw-Cage Clamp Connection
- LED Coil Voltage Indicator
- Reverse DC Polarity LED Protection
- Surge Suppression With DC Coils
- Industry Standard Relays
- DIN Rail Mount, Panel Mount Available

Isolated Channel* (no bus)	Coil Voltage	Contact Material: AgSnO <sub>2</sub> +0.2µmAu	Contact Material: AgNi10+0.2µmAu	Contact Material: AgNi10+5µmAu	Module Length (L) in mm (in)
		Contact Ratings: 8A 250VDC, 400VAC	Contact Ratings: 8A 250VDC, 400VAC	Contact Ratings: 8A 250VDC, 400VAC	
		Part Number	Part Number	Part Number	
1 Channel	12V	8949.2C	8949.2N	8949.2S	21 (0.83)
1 Channel	24V	8951.2C	8951.2N	8951.2S	21 (0.83)
2 Channel	12V	8949.3C	8949.3N	8949.3S	40 (1.57)
2 Channel	24V	8951.3C	8951.3N	8951.3S	40 (1.57)
4 Channel	12V	8955.2C	8955.2N	8955.2S	79 (3.11)
4 Channel	24V	8956.2C	8956.2N	8956.2S	79 (3.11)
8 Channel	12V	8955.3C	8955.3N	8955.3S	157 (6.18)
8 Channel	24V	8956.3C	8956.3N	8956.3S	157 (6.18)
16 Channel	12V	8963.2C	8963.2N	8963.2S	311 (12.24)
16 Channel	24V	8972.2C	8972.2N	8972.2S	311 (12.24)

\*Each Channel is one DPDT relay

# Safety Relay Modules

Isolated Channels - 8 Amp Contacts, 35 or 32 DIN Rail



## Relay Pinout

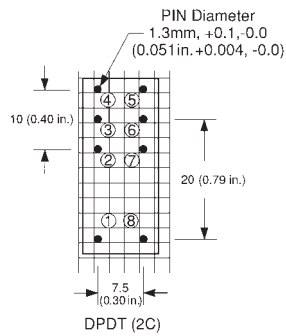

Bottom View, Relay Pinouts, Grid 2.54mm (0.1in.)

## Coil Circuits

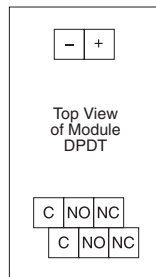
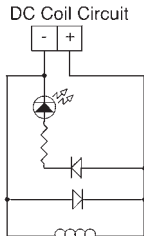

## Contact Circuits

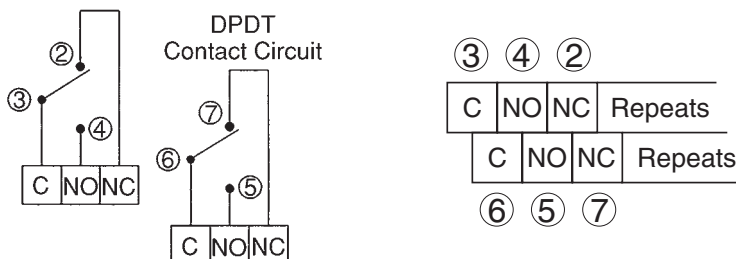

## Relay Specifications

-Normal Coil Voltage:	12,24 VDC
-Coil Power Dissipation:	0.7W
-Max. Switching Voltage:	250 VDC, 400 AC
-Max. Switching Current:	8A(2x5A simultaneous)
-Max. Switching Power	
DC	200W
AC	2000VA
-AgNi10+5µmAu	
Max Switching Voltage	60VAC/DC
Max Switching Current	0.3A
Max Switching Power	
AC	12VA
DC	12W
-Contact Switching Rate:	10 operations/ sec.
-Relay Operate Time	≤15 ms
-Relay Release Time	≤12 ms
-Contact Arrangements	DPDT, 2 FORM C
-Contact Material:	
Standard	AgNi10+0.2µmAu
Optional	AgSnO <sub>2</sub> +0.2µmAu
	AgNi10+5µmAu
-Mechanical Life:	≥50x10 <sup>6</sup> operation cycles
-Ambient Temperature:	-40°+ 70°C
-Cover Material:	Polyamide 6
-Weight:	19g

## Coil Specifications

Rated Voltage	Voltage Range	Coil Resistance
12VDC	9.6V-19.2V	210Ω ± 10%
24VDC	19.2V-38.4V	820Ω ± 10%

# Safety Relay Modules

## Bussed Channels - 8 Amp Contacts, 35 or 32 DIN Rail

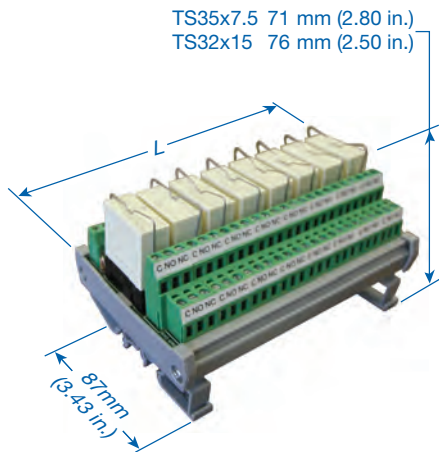

### Bussed Channel (Double Pole Double Throw)

Altech Safety Relay Modules utilize Relays with Force-Guided-Contacts that meet or exceed international standards, TÜV and UL. They are designed to protect man and machine as specified in OSHA FR1910 Regulations, a mandatory requirement of the European Machinery Directive EMD 89.392 EEC. The Safety Relays are used in Safety Devices such as Emergency Stop Modules, Safety Gate Monitors, 2-Hand Safety Modules, etc.

This series of Safety Relay Modules are Double Pole, Double Throw configurations, and are available as 1, 2, 4, 8 and 16 isolated channels and 8 and 16 bussed channels with 12 or 24 VDC coils. Isolated channels allow control of each relay by a different logic system, if necessary. There are two inputs for each relay coil per channel. Bussed channels allow high density packaging with a common input for all relays. Safety Relay Modules may be ordered with three different types of relay contact material, depending on the actual load current.

- Screw-Cage Clamp Connection
- LED Coil Voltage Indicator
- Reverse DC Polarity LED Protection
- Surge Suppression With DC Coils
- Industry Standard Relays
- DIN Rail Mount, Panel Mount Available

Bussed Channels*	Coil Voltage	Contact Material: AgSnO <sub>2</sub> +0.2µmAu	Contact Material: AgNi10+0.2µmAu	Contact Material: AgNi10+5µmAu	Module Length (L) in mm (in)
		Contact Ratings: 8A 250VDC, 400VAC	Contact Ratings: 8A 250VDC, 400VAC	Contact Ratings: 8A 250VDC, 400VAC	
		Part Number	Part Number	Part Number	
8 Channel, DC+	12V	8923.2C	8923.2N	8923.2S	125 (4.92)
8 Channel, DC+	24V	8924.2C	8924.2N	8924.2S	125 (4.92)
8 Channel, DC-	12V	8923.3C	8923.3N	8923.3S	125 (4.92)
8 Channel, DC-	24V	8924.4C	8924.4N	8924.4S	125 (4.92)
16 Channel, DC+	12V	8926.2C	8926.2N	8926.2S	248 (9.76)
16 Channel, DC+	24V	8926.3C	8926.3N	8926.3S	248 (9.76)
16 Channel, DC-	12V	8927.2C	8927.2N	8927.2S	248 (9.76)
16 Channel, DC-	24V	8927.3C	8927.3N	8927.3S	248 (9.76)

\*Each Channel is one DPDT relay



# Safety Relay Modules

Bussed Channels - 8 Amp Contacts, 35 or 32 DIN Rail



## Relay Pinout

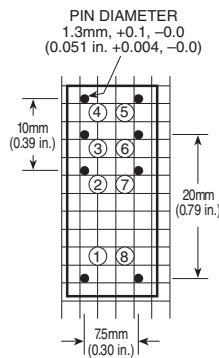

## Coil Circuits

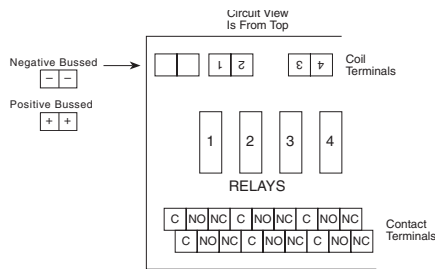
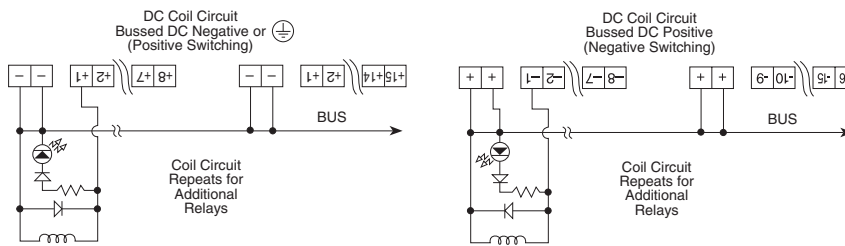

## Contact Circuits

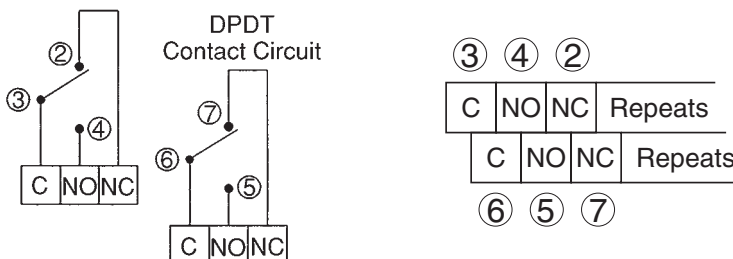

## Relay Specifications

-Normal Coil Voltage:	12,24 VDC
-Coil Power Dissipation:	0.7W
-Max. Switching Voltage:	250 VDC, 400 AC
-Max. Switching Current:	8A(2x5A simultaneous)
-Max. Switching Power	
DC	200W
AC	2000VA
-AgNi10+5µmAu	
Max Switching Voltage	60VAC/DC
Max Switching Current	0.3A
Max Switching Power	
AC	12VA
DC	12W
-Contact Switching Rate:	10 operations/ sec.
-Relay Operate Time	≤15 ms
-Relay Release Time	≤12 ms
-Contact Arrangements	DPDT, 2 FORM C
-Contact Material:	
Standard	AgNi10+0.2µmAu
Optional	AgSnO <sub>2</sub> +0.2µmAu
	AgNi10+5µmAu
-Mechanical Life:	≥50x10 <sup>6</sup> operation cycles
-Ambient Temperature:	-40°+ 70°C
-Cover Material:	Polyamide 6
-Weight:	19g

## Coil Specifications

# Safety Relay Modules

## 4 Pole Relays - 8 Amp, 35 or 32 DIN Rail

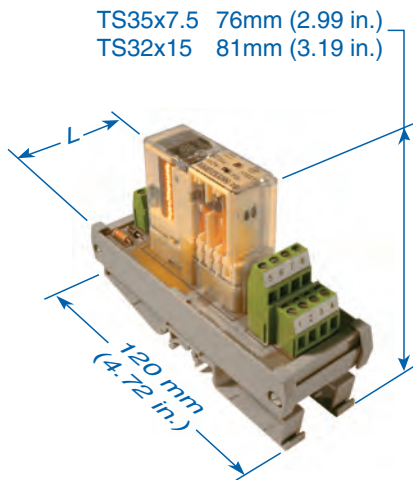

### 4 Pole, 8 Amp

Altech Safety Relay Modules utilize Relays with Force-Guided-Contacts that meet or exceed international standards, TÜV and UL. They are designed to protect man and machine as specified in OSHA CFR1910 Regulations, which is a mandatory requirement of the European Machinery Directive EMD 89.392 EEC.

- Screw-Cage clamp Connections
- LED Coil Voltage Indicator
- Reverse DC Polarity LED Protection
- Surge Suppression With DC Coil
- Din Rail Mount, Panel Mount Available

Altech Safety Relays are electro-mechanical relays that are mechanically linked together, causing all contacts to move together when the coil is energized. Force-Guided-contacts are also known as positive-guided-contacts, captive contacts or locked contacts. In addition, our Safety Relays have Crown Contacts which provide two locations per contacts to improve switching conditions. The Safety Relays are used in Safety Devices such as Emergency Stop Modules, Safety Gate Monitors, 2-Hand Safety Modules, Safety Light Curtains, etc.

This series of Safety Relay Modules consist of 4 pole relays with two choices of configurations (2NO/2NC or 3NO/1NC), with 8 or 10 Amp contacts, and are available as 1,2, and 4 isolated channels with 12, or 24 VDC coils. Isolated channels allows control of each relay by a different logic system, if necessary. There are two inputs for each relay coil per channel. Safety Relay Modules may be ordered with three different types of relay contact material, depending on the actual load current. The part numbers shown in this data sheet are for our standard contact material, which is AgSnO<sub>2</sub> + 0.2µmAu.

		Contact Material*: AgSnO <sub>2</sub> + 0.2µmAu		Module Length (L) in mm (in)
		Contact Ratings: 8A 250VDC, 400VAC		
		Contact Ratings:		
		2N.0 + 2N.C	3N.0 + 1N.C	
Isolated Channel <sup>1</sup>	Coil Voltage	Part Number	Part Number	
1 Channel	12V	156.0A11.1222C	156.0A11.1231C	40.10 (1.58)
1 Channel	24V	156.0A11.2422C	156.0A11.2431C	40.10 (1.58)
2 Channel	12V	256.0A11.1222C	256.0A11.1231C	78.20 (3.08)
2 Channel	24V	256.0A11.2422C	256.0A11.2431C	78.20 (3.08)
4 Channel	12V	456.0A11.1222C	456.0A11.1231C	154.40 (6.08)
4 Channel	24V	456.0A11.2422C	456.0A11.2431C	154.40 (6.08)

<sup>1</sup>Each Channel is one 4 pole relay

\* Note: Additional relay contact materials are available upon request. Please contact Altech for additional information.

# Safety Relay Modules

4 Pole Relays - 8 Amp, 35 or 32 DIN Rail

## 4 Pole, 8 Amp

### DC Coil Circuits

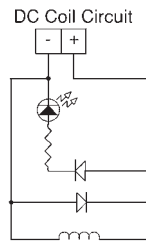

### Contact Circuits

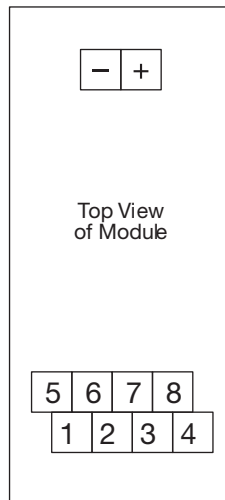

### Relay Configurations

- 2 N.O + 2 N.C  
NO Pin (1,2), (5,6)  
NC Pin (3,4), (7,8)
- 3 N.O + 1 N.C  
NO Pin (1,2), (5,6), (7,8)  
NC Pin (3,4)

### Relay Specifications - 8 Amps

- Normal Coil Voltage: 12,24 VDC
- Coil Power Dissipation: 0.6W
- Max. Switching Voltage: 250VDC, 400VAC
- Max. Switching Current: 8A(3x8A simultaneous)
- Max. Switching Power  
DC 200W  
AC 2000VA
- Contact Switching Rate: 10 operations/ sec.
- Relay Operate Time 20 ms
- Relay Release Time 6 ms
- Contact Arrangements 2NO/2NC, 3NO/1NC
- Contact Material:  
Standard AgSnO<sub>2</sub>+0.2μmAu  
Optional AgNi10+0.2μmAu  
AgNi10+5μmAu
- Mechanical Life: ≥50x10<sup>6</sup> operation cycles
- Ambient Temperature: -40°+ 85°C
- Cover Material: Thermoplastic
- Weight: 35g

### Coil Specifications

Rated Voltage	Voltage Range	Coil Resistance
12VDC	8.4V-16.8V	240Ω ± 10%
24VDC	16.8V-33.6V	960Ω ± 10%

# Safety Relay Modules

## 4 Pole Relays - 10 Amp, 35 or 32 DIN Rail

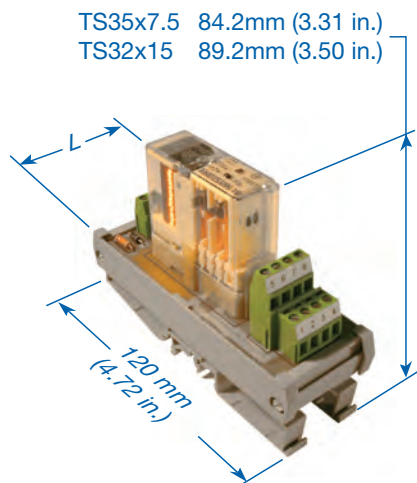

### 4 Pole, 10 Amp

Altech Safety Relay Modules utilize Relays with Force-Guided-Contacts that meet or exceed international standards, TÜV and UL. They are designed to protect man and machine as specified in OSHA CFR1910 Regulations, which is a mandatory requirement of the European Machinery Directive EMD 89.392 EEC.

- Screw-Cage clamp Connections
- LED Coil Voltage Indicator
- Reverse DC Polarity LED Protection
- Surge Suppression With DC Coil
- Din Rail Mount, Panel Mount Available

Altech Safety Relays are electro-mechanical relays that are mechanically linked together, causing all contacts to move together when the coil is energized. Force-Guided-contacts are also known as positive-guided-contacts, captive contacts or locked contacts. In addition, our Safety Relays have Crown Contacts which provide two locations per contacts to improve switching conditions. The Safety Relays are used in Safety Devices such as Emergency Stop Modules, Safety Gate Monitors, 2-Hand Safety Modules, Safety Light Curtains, etc.

This series of Safety Relay Modules consist of 4 pole relays with two choices of configurations (2NO/2NC or 3NO/1NC), with 8 or 10 Amp contacts, and are available as 1,2, and 4 isolated channels with 12, or 24 VDC coils. Isolated channels allows control of each relay by a different logic system, if necessary. There are two inputs for each relay coil per channel. Safety Relay Modules may be ordered with three different types of relay contact material, depending on the actual load current. The part numbers shown in this data sheet are for our standard contact material, which is  $AgSnO_2 + 0.2\mu mAu$ .

		Contact Material*: $AgSnO_2 + 0.2\mu mAu$		Module Length (L) in mm (in)
		Contact Ratings: 10A 250VDC, 400VAC		
		2N.0 + 2N.C	3N.0 + 1N.C	
Isolated Channels <sup>1</sup>	Coil Voltage	Part Number	Part Number	
1 Channel	12V	156.0A01.1222C	156.0A01.1231C	40.10 (1.58)
1 Channel	24V	156.0A01.2422C	156.0A01.2431C	40.10 (1.58)
2 Channel	12V	256.0A01.1222C	256.0A01.1231C	78.20 (3.08)
2 Channel	24V	256.0A01.2422C	256.0A01.2431C	78.20 (3.08)
4 Channel	12V	456.0A01.1222C	456.0A01.1231C	154.40 (6.08)
4 Channel	24V	456.0A01.2422C	456.0A01.2431C	154.40 (6.08)

<sup>1</sup>Each Channel is one 4 pole relay

\* Note: Additional relay contact materials are available upon request. Please contact Altech for additional information.

# Safety Relay Modules

4 Pole Relays - 10 Amp, 35 or 32 DIN Rail

## 4 Pole, 10 Amp

### DC Coil Circuits

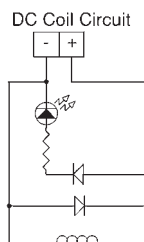

### Contact Circuits

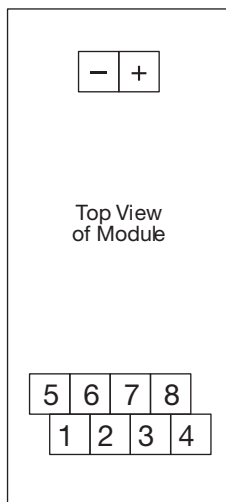

### Relay Configurations

- 2 N.O + 2 N.C
  - NO Pin (3,4), (7,8)
  - NC Pin (1,2), (5,6)
- 3 N.O + 1 N.C
  - NO Pin (3,4), (5,6), (7,8)
  - NC Pin (1,2)

### Relay Specifications - 10 Amps

- Normal Coil Voltage: 12,24 VDC
- Coil Power Dissipation: 0.75W
- Max. Switching Voltage: 250VDC, 400VAC
- Max. Switching Current: 10A(3x10A simultaneous)
- Max. Switching Power
  - DC 240W
  - AC 2500VA
- Contact Switching Rate: 10 operations/ sec.
- Relay Operate Time: 27 ms
- Relay Release Time: 5 ms
- Contact Arrangements: 2NO/2NC, 3NO/1NC
- Contact Material:
  - Standard AgSnO<sub>2</sub>+0.2μmAu
  - Optional AgNi10+0.2μmAu
  - AgNi10+5μmAu
- Mechanical Life: >30x10<sup>6</sup> operation cycles
- Ambient Temperature: -40°+ 85°C
- Cover Material: Thermoplastic
- Weight: 78g

### Coil Specifications

Rated Voltage	Voltage Range	Coil Resistance
12VDC	8.4V-19.2V	192Ω ± 10%
24VDC	16.8V-38.4V	770Ω ± 10%

# Safety Relay Modules

## 6 Pole Relays - 8 Amp, 35 or 32 DIN Rail

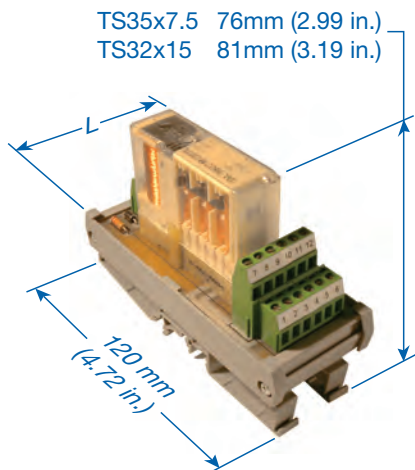

### 6 Pole, 8 Amp

Altech Safety Relay Modules utilize Relays with Force-Guided-Contacts that meet or exceed international standards, TÜV, SA, SUVA, and UL. They are designed to protect man and machine as specified in OSHA CFR1910 Regulations, which is a mandatory requirement of the European Machinery Directive EMD 89.392 EEC.

- Screw-Cage clamp Connections
- LED Coil Voltage Indicator
- Reverse DC Polarity LED Protection
- Surge Suppression With DC Coil
- Din Rail Mount, Panel Mount Available

Altech Safety Relays are electro-mechanical relays that are mechanically linked together, causing all contacts to move together when the coil is energized. Force-Guided-contacts are also known as positive-guided-contacts, captive contacts or locked contacts. In addition, our Safety Relays have Crown Contacts which provides two locations per contacts to improve switching conditions. The Safety Relays are used in Safety Devices such as Emergency Stop Modules, Safety Gate Monitors, 2-Hand Safety Modules, Safety Light Curtains, etc.

This series of Safety Relay Modules consist of 6 pole relays with three configuration choices (2NO+4NC, 3NO+3NC, 4NO+2NC), 8 or 10 Amp contacts and either 1, 2 and 4 isolated channels with 12 or 24 VDC coils. Isolated channels allow control of each relay by a different logic system, if necessary. There are two inputs for each relay coil channel. Modules can be ordered with three contact materials, dependent upon the actual current load. The standard contact material is AgSnO<sub>2</sub>+0.2µmAu.

Isolated Channels <sup>1</sup>	Coil Voltage	Contact Material*: AgSnO <sub>2</sub> +0.2µmAu			Module Length (L) in mm (in)
		2N.O + 4N.C	3N.O + 3N.C	4N.O + 2N.C	
		Part Number	Part Number	Part Number	
1 Channel	12V	156.OA12.1224C	156.OA12.1233C	156.OA12.1242C	46.45 (1.83)
1 Channel	24V	156.OA12.2424C	156.OA12.2433C	156.OA12.2442C	46.45 (1.83)
2 Channel	12V	256.OA12.1224C	256.OA12.1233C	256.OA12.1242C	90.90 (3.58)
2 Channel	24V	256.OA12.2424C	256.OA12.2433C	256.OA12.2442C	90.90 (3.58)
4 Channel	12V	456.OA12.1224C	456.OA12.1233C	456.OA12.1242C	179.80 (7.08)
4 Channel	24V	456.OA12.2424C	456.OA12.2433C	456.OA12.2442C	179.80 (7.08)

<sup>1</sup>Each Channel is one 6 pole relay

\* Note: Additional relay contact materials are available upon request. Please contact Altech for additional information.

# Safety Relay Modules

6 Pole Relays - 8 Amp, 35 or 32 DIN Rail



## 6 Pole, 8 Amp

### DC Coil Circuits

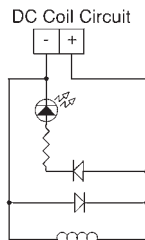

### Contact Circuits

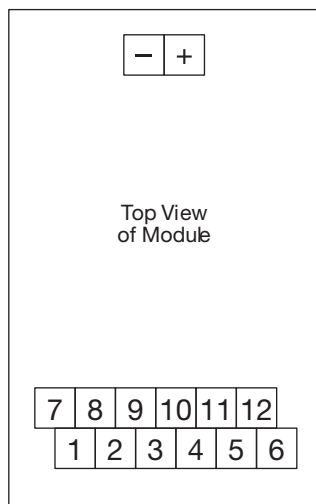

#### Relay Configurations

- 2N.0 + 4N.C
  - NO Pin (1,2), (7,8)
  - NC Pin (3,4), (5,6), (9,10), (11,12)
- 3N.0 + 3N.C
  - NO Pin (1,2), (7,8), (9,10)
  - NC Pin (3,4), (5,6), (11,12)
- 4N.0 + 2N.C
  - NO Pin (1,2), (3,4), (7,8), (9,10)
  - NC Pin (5,6), (11,12)

### Relay Specifications - 8 Amps

- Normal Coil Voltage: 12,24 VDC
- Coil Power Dissipation: 0.8-1.0 W\*
- Max. Switching Voltage: 250VDC, 400VAC
- Max. Switching Current: 8A(5x8A simultaneous)
- Max. Switching Power
  - DC 200W
  - AC 2000VA
- Contact Switching Rate: 10 operations/ sec.
- Relay Operate Time 20 ms
- Relay Release Time 6 ms
- Contact Arrangements 2NO/4NC\*, 3NO/3NC, 4NO/2NC
- Contact Material:
  - Standard AgSnO<sub>2</sub>+0.2μmAu
  - Optional AgNi10+.0.2μmAu  
AgNi10+5μmAu
- Mechanical Life: ≥50x10<sup>6</sup> operation cycles
- Ambient Temperature: -40° + 85°C
- Cover Material: Thermoplastic
- Weight: 38g

### Coil Specifications

Rated Voltage	Voltage Range	Coil Resistance
12VDC	8.4V-16.8V	145Ω ± 10%
24VDC	16.8V-33.6V	600Ω ± 10%

# Safety Relay Modules

## 6 Pole Relays - 10 Amp, 35 or 32 DIN Rail

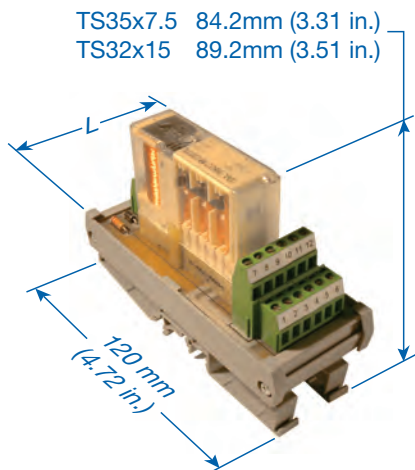

### 6 Pole, 10 Amp

Altech Safety Relay Modules utilize Relays with Force-Guided-Contacts that meet or exceed international standards, TÜV, SA, SUVA, and UL. They are designed to protect man and machine as specified in OSHA CFR1910 Regulations, which is a mandatory requirement of the European Machinery Directive EMD 89.392 EEC.

- Screw-Cage clamp Connections
- LED Coil Voltage Indicator
- Reverse DC Polarity LED Protection
- Surge Suppression With DC Coil
- Din Rail Mount, Panel Mount Available

Altech Safety Relays are electro-mechanical relays that are mechanically linked together, causing all contacts to move together when the coil is energized. Force-Guided-contacts are also known as positive-guided-contacts, captive contacts or locked contacts. In addition, our Safety Relays have Crown Contacts which provides two locations per contacts to improve switching conditions. The Safety Relays are used in Safety Devices such as Emergency Stop Modules, Safety Gate Monitors, 2-Hand Safety Modules, Safety Light Curtains, etc.

This series of Safety Relay Modules consist of 6 pole relays with three configuration choices (2NO+4NC, 3NO+3NC, 4NO+2NC), 8 or 10 Amp contacts and either 1, 2 and 4 isolated channels with 12 or 24 VDC coils. Isolated channels allow control of each relay by a different logic system, if necessary. There are two inputs for each relay coil channel. Modules can be ordered with three contact materials, dependent upon the actual current load. The standard contact material is  $AgSnO_2+0.2\mu mAu$ .

Isolated Channels <sup>1</sup>	Coil Voltage	Contact Material*: AgSnO <sub>2</sub> +0.2μmAu			Module Length (L) in mm (in)
		Contact Ratings: 10A 250VDC,400VAC			
		2N.O + 4N.C	3N.O + 3N.C	4N.O + 2N.C	
		Part Number	Part Number	Part Number	
1 Channel	12V	156.0A02.1224C	156.0A02.1233C	156.0A02.1242C	46.45 (1.83)
1 Channel	24V	156.0A02.2424C	156.0A02.2433C	156.0A02.2442C	46.45 (1.83)
2 Channel	12V	256.0A02.1224C	256.0A02.1233C	256.0A02.1242C	90.90 (3.58)
2 Channel	24V	256.0A02.2424C	256.0A02.2433C	256.0A02.2442C	90.90 (3.58)
4 Channel	12V	456.0A02.1224C	456.0A02.1233C	456.0A02.1242C	179.80 (7.08)
4 Channel	24V	456.0A02.2424C	456.0A02.2433C	456.0A02.2442C	179.80 (7.08)

<sup>1</sup>Each Channel is one 6 pole relay

\* Note: Additional relay contact materials are available upon request. Please contact Altech for additional information.



# Safety Relay Modules

6 Pole Relays - 10 Amp, 35 or 32 DIN Rail



## 6 Pole, 10 Amp

### DC Coil Circuits

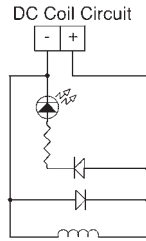

### Contact Circuits

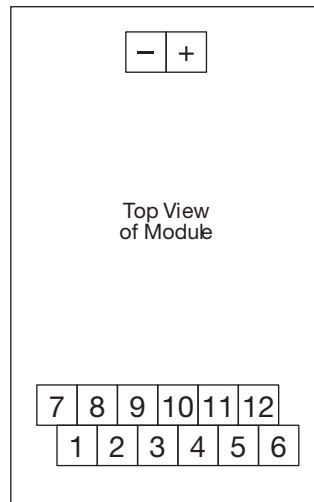

#### Relay Configurations

2N.0 + 4N.C  
 NO Pin (5,6), (11,12)  
 NC Pin (1,2), (3,4), (7,8), (9,10)

3N.0 + 3N.C  
 NO Pin (3,4), (5,6), (11,12)  
 NC Pin (1,2), (7,8), (9,10)

4N.0 + 2N.C  
 NO Pin (3,4), (5,6), (9,10), (11,12)  
 NC Pin (1,2), (7,8)

### Relay Specifications - 10 Amps

- Normal Coil Voltage: 12,24 VDC
- Coil Power Dissipation: 1.0 W
- Max. Switching Voltage: 250VDC, 400VAC
- Max. Switching Current: 10A(4x10A simultaneous)
  
- Max. Switching Power
  - DC 240W
  - AC 2500VA
  
- Contact Switching Rate: 10 operations/ sec.
- Relay Operate Time 27 ms
- Relay Release Time 5 ms
- Contact Arrangements 2NO/4NC, 3NO/3NC, 4NO/2NC
  
- Contact Material:
  - Standard AgSnO<sub>2</sub>+0.2μmAu
  - Optional AgNi10+0.2μmAu  
AgNi10+5μmAu
  
- Mechanical Life: ≥30x10<sup>6</sup> operation cycles
- Ambient Temperature: -40°+ 85°C
- Cover Material: Thermoplastic
- Weight: 85g

### Coil Specifications

Rated Voltage	Voltage Range	Coil Resistance
12VDC	8.4V-19.2V	140Ω ± 10%
24VDC	16.8V-38.4V	570Ω ± 10%

# Safety Relay Modules

## 8 Pole - 10 Amp, 35 or 32 DIN Rail

### 8 Pole, 10 Amp

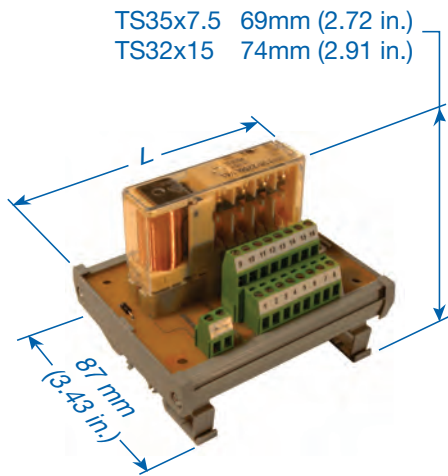

These Safety Relay Modules utilize Relays with Force-Guided-Contacts that meet or exceed international standards, TÜV, SA, SUVA, and UL. They meet the standard EN50205 for safety relays, UL/94/VO fire protection, VDE 0106 Protection Class 11, and VDE 0110/group C 250VAC insulation class.

- Screw-Cage clamp Connections
- LED Coil Voltage Indicator
- Reverse DC Polarity LED Protection
- Surge Suppression With DC Coil
- Din Rail Mount, Panel Mount Available

Altech Safety Relays are electro-mechanical relays that are mechanically linked together, causing all contacts to move together when the coil is energized. Force-Guided-contacts are also known as positive-guided-contacts, captive contacts or locked contacts. In addition, our Safety Relays have Crown Contacts which provides two locations per contacts to improve switching conditions. The Safety Relays are used in Safety Devices such as Emergency Stop Modules, Safety Gate Monitors, 2-Hand Safety Modules, Safety Light Curtains, etc.

This series of Safety Relay Modules consists of 8 pole relays with 10 Amps in six configurations choices. Standard contact material for this series is  $\text{AgSnO}_2 + 0.2\mu\text{mAu}$ .

		<b>Contact Material*:</b> AgSnO <sub>2</sub> +0.2μmAu			<b>Module Length (L)</b> <b>in mm (in)</b>
		<b>Contact Ratings:</b> 10A 250VDC, 400VAC			
		<b>Contacts:</b> 7 NO/1 NC	<b>Contacts:</b> 6 NO/2 NC	<b>Contacts:</b> 5 NO/3 NC	
	<b>Coil Voltage</b>	<b>Part Number</b>	<b>Part Number</b>	<b>Part Number</b>	
1 Channel	12	156.OA03.1271C	156.OA03.1262C	156.OA03.1253C	103.6 (4.08)
1 Channel	24	156.OA03.2471C	156.OA03.2462C	156.OA03.2453C	103.6 (4.08)

		<b>Contacts:</b> 4 NO/4 NC	<b>Contacts:</b> 3 NO/5 NC	<b>Contacts:</b> 2 NO/6 NC	<b>Module Length (L)</b> <b>in mm (in)</b>
	<b>Coil Voltage</b>	<b>Part Number</b>	<b>Part Number</b>	<b>Part Number</b>	
1 Channel	12	156.OA03.1244C	156.OA03.1235C	156.OA03.1226C	103.6 (4.08)
1 Channel	24	156.OA03.2444C	156.OA03.2435C	156.OA03.2426C	103.6 (4.08)

# Safety Relay Modules

## 8 Pole - 10 Amp, 35 or 32 DIN Rail

### 8 Pole, 10 Amp

#### DC Coil Circuits

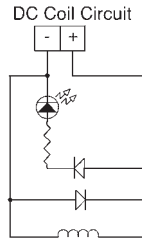

#### Contact Circuits

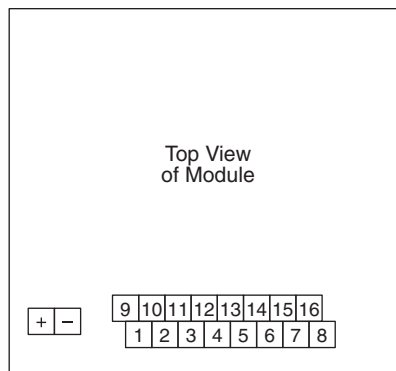

#### Relay Configurations

- 2NO/6NC  
NO Pin (7,8), (15,16)  
NC Pin (1,2), (3,4), (5,6), (9,10), (11,12), (13,14)
- 3NO/5NC  
NO Pin (5,6), (7,8), (15,16)  
NC Pin (1,2), (3,4), (9,10), (11,12), (13,14)
- 4NO /4NC  
NO Pin (5,6), (7,8), (13,14), (15,16)  
NC Pin (1,2), (3,4), (9,10), (11,12), (13,14)
- 5NO /3NC  
NO Pin (3,4), (5,6), (7,8), (13,14), (15,16)  
NC Pin (1,2), (9,10), (11,12)
- 6NO /2NC  
NO Pin (3,4), (5,6), (7,8), (11,12), (13,14), (15,16)  
NC Pin (1,2), (9,10)
- 7NO /1NC  
NO Pin (1,2), (3,4), (5,6), (7,8), (9,10), (11,12), (13,14), (15,16)  
NC Pin (9,10)

#### Relay Specifications - 8 Pole

- Normal Coil Voltage: 12, 24 VDC
- Coil Power Dissipation: 1.25-1.65W<sup>1</sup>
- Max. Switching Voltage: 250VDC, 400VAC
- Max. Switching Current: 10A
- Max. Switching Power:
  - DC 240W
  - AC 2500VA
- Contact Switching Rate: 10 operations per second
- Relay Operate Time 27 ms
- Relay Release Time 5 ms
- Contact Arrangements:
  - 2NO/6NC<sup>1</sup>
  - 3NO/5NC<sup>1</sup>
  - 4NO/4NC
  - 5NO/3NC
  - 6NO/2NC
  - 7NO/1NC
- Contact Material: AgSnO<sub>2</sub>+0.2µmAu
- Mechanical Life: 30x10<sup>6</sup> operation cycles
- Ambient Temperature: -40° + 75°C
- Weight: 95g

#### Coil Specifications

Rated Voltage	Min. Pick-up	Coil Resistance
12VDC	8.4V-15.2V	88Ω/112Ω ± 15%*
24VDC	16.8V-38.4V	370Ω/460Ω ± 15%*

\* 88Ω/370Ω for contact arrangements  
2NO/6NC, 3NO/5NC

\* 112Ω/460Ω for contact arrangements  
4NO/4NC, 5NO/3NC/6NO/2NC/7NO/7NC

# Accessories



PCB Socket for OA/OW 5669\*



PCB Socket for OA/OW 5670\*

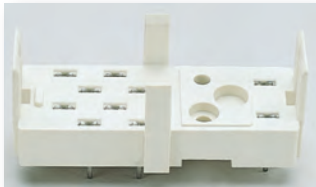

Socket for OA 5601\*

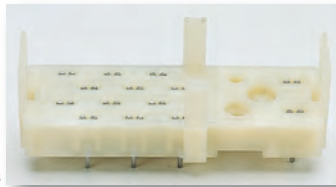

Socket for OA 5602\*

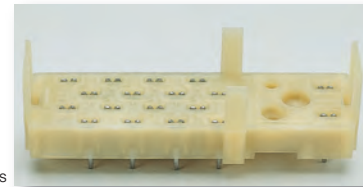

Socket for OA 5603\*

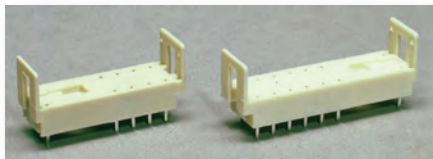

Socket for OA 5611/12\*



Socket for OA 5621/22\*



DIN Rail Socket for OA/OW 5669\*



Extraction Tool

## Ordering Information

Relay Style	Matching Socket	Socket Type	Extraction-Tool Type	Hold Down Clip Type	LED Module AC/DC, Green LED	Diode Module DC Red, LED
OA/OW 5669	56.5669.00	PCB	n.a.	56.5669.99	n.a.	n.a.
OA/OW 5669	56.5669.DR	DIN Rail	n.a.	included	56.5669.GR	56.5669.RE
OA 5667	n.a.	PCB	n.a.	n.a.	n.a.	n.a.
OA 5601	56.5601.01	PCB	56.5601.10	n.a.	n.a.	n.a.
OA 5602	56.5602.02	PCB	56.5602.20	n.a.	n.a.	n.a.
OA 5603	56.5603.03	PCB	n.a.	n.a.	n.a.	n.a.
OA 5611	56.5611.11	PCB	n.a.	n.a.	n.a.	n.a.
OA 5612	56.5612.12	PCB	n.a.	n.a.	n.a.	n.a.
OA 5621	56.5621.21	PCB	n.a.	n.a.	n.a.	n.a.
OA 5622	56.5622.22	PCB	n.a.	n.a.	n.a.	n.a.
OA 5670	56.5670.70	PCB	n.a.	n.a.	n.a.	n.a.

\*Current data sheets of sockets are available on request.

Safety relays with forced-guided contacts are the core components for safety devices and are indispensable when designing safety circuits. Safety devices are designed to protect man and machine as demanded in OSHA CFR 1910 Regulations “General Requirements for All Machinery”, and which is a mandatory requirement of the European Machinery Directive EMD 2006/42/EC.

DOLD safety relays, manufactured according to DIN EN 50205 and IEC/EN61810 are approved for use in safety applications to IEC 60204, EN 60204, DIN/VDE 0113, as well as Escalator Standard EN 115/06.95 and Elevator Standard EN 81-1 (electric) and EN81-2 (hydraulic), and in safety related parts of control systems in IEC/EN 62061 and EN ISO 13849.

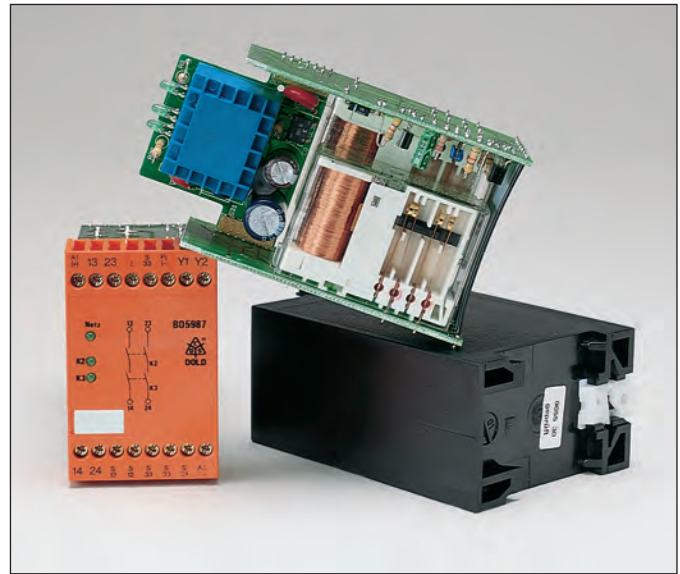

## Typical Applications

- Emergency stop modules
- DIN Rail safety modules
- Safety door controls
- Two-hand operating devices
- Pressure mat controls
- Light barriers and curtains
- Speed controls
- Monitoring devices

## Equipment controls systems for:

- Elevators and escalators
- Cranes
- Door and gate drive systems
- Printing and textile machinery
- Robots
- Stamping machines
- Medical equipment
- Cutting machines
- Rail transportation systems
- Signaling systems
- Press systems

### WARNING

**Improper** use and installation of safety relays - modules into safety related circuitry without complying with the applicable regulations can cause serious injury to the operator.

**Due** to the wide range of potential users and customers' interpretation of the standards covering the applications of the safety relays described in this brochure, it is impossible for DOLD personnel or sales agents to be familiar with all safety and health standards and requirements that may apply to any specific application.

**It** is the responsibility of the user to determine the suitability of a safety relay for the intended application and to determine that the safety relay chosen and its installation will comply with all applicable safety and health regulations and codes.

# Relay Terminology

**Ambient Temperature:** The temperature of the surrounding medium that comes in contact with the device/ equipment.

**Breakdown Voltage:** The minimum root-mean-square (rms) value of a sinusoidal voltage that results in sparkover.

**Coil, relay:** One or more windings on a common form.

**Coil Power Dissipation:** The amount of electric power consumed by a winding. For the most practical purpose, this equals the  $I^2R$  loss.

**Coil Resistance:** The total terminal-to-terminal resistance of a coil at a specified temperature.

**Contact Gap:** The final length of the isolating distance between mating contacts when the contacts are open.

**Contact Arrangement:** The combination of contact forms that make up the entire relay switching structure.

**Contact Housing:** The part that provides means for mounting fixed contacts on a supporting structure.

**Contact Material:** Substance or combination of substances used as constituents in the manufacture of the contacts.

**AgSnO<sub>2</sub> + 0.2μmAu:** Silver-Tin Dioxide with a 0.2 layer of gold. Medium to high current applications for resistive, capacitive and particular inductive loads, 10mA-10A.

**AgNi10+ 0.2μmAu:** Silver-Nickel 10 with a 0.2 layer of gold. Medium to high current applications, 10mA-10A.

**AgNi10+ 5μmAu:** Silver-Nickel 10 with a 5 layer of gold. Low current applications only, where switching of very low current is crucial; 2mA-300mA, 2V-60V.

**Contact Pressure:** Force exerted by one contact against the mating contact of a relay.

**Contact Switching Rate:** The velocity at which contact switching occurs, e.g., 10 switching operations per second.

**Corrosion:** The deterioration of a substance, usually a metal, because of a reaction with its environment.

**Cover Material:** Substance or combination of substances used as constituents in the manufacture of a protective covering used to enclose equipment.

**Creeping Distance:** The shortest distance between two conducting parts measured along the surface or joints of the insulating material between them.

## Safety Relay Selection Material Table

Material	Characteristics	Applications	Range
AgSnO <sub>2</sub> + 0.2μmAu <b>C</b>	very low welding tendency highest burn-up resistivity very good arc suppression	special for switching, inductive loads	10mA - 10A
AgNi10 + 0.2μmAu <b>N</b>	low welding tendency high burn-up resistivity good arc suppression	circuits with medium to high switching current, DC current circuits	10mA - 10A
AgNi10 + 5μmAu <b>S</b>	higher welding tendency low burn-up resistivity low contact resistance	where very low to medium switching current and voltage is mandatory	2mA - 300mA

**Crown Contacts:** Improved contact form to enforce high contact stress on at least two spots on the contact to penetrate any built-up contamination; to maintain low contact resistance throughout the life of a relay; and to increase the value of switchable output voltage. Supports low current to high power applications.

**Custom Design:** Special design to meet customer requirements regarding coil voltage, coil resistance, contact pressure, and relay operate/release time. Possible alteration of max. 3 specifications from the original standard value while the remaining 1 is retained at its original value.

## Graphic Symbols

Contact Name Symbol	Short Form	DIN / IEC Symbol	UL / CSA
Normally Open	NO, Form A		
Normally Closed	NC, Form B		
Changeover	CO, Form C, SPDT		

**Forced-Guided Contacts:** Electro-mechanical relay contacts that are mechanically linked together, so that when the relay coil is energized or de-energized, all of the linked contacts move together. If one set of contacts in the relay becomes immobilized, no other contact of the same relay will be able to move. An open-contact gap > 0.5 mm ( 0.02 in.) is maintained during life of the relay, even with malfunction, and at 1.6 x Nominal Voltage. Forced-Guided contacts are also known as captive contacts, positive-guided contacts, or locked contacts. They are used in Safety Relays.

## Forced-Guided versus Standard Relay Contacts

### Forced-Guided Relay Contacts

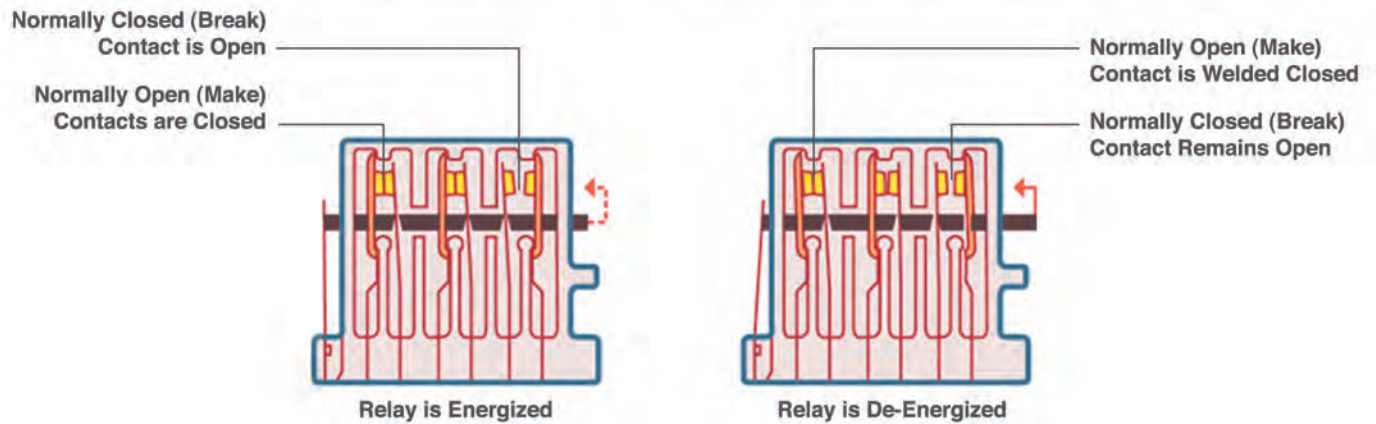

### Standard Relay Contacts

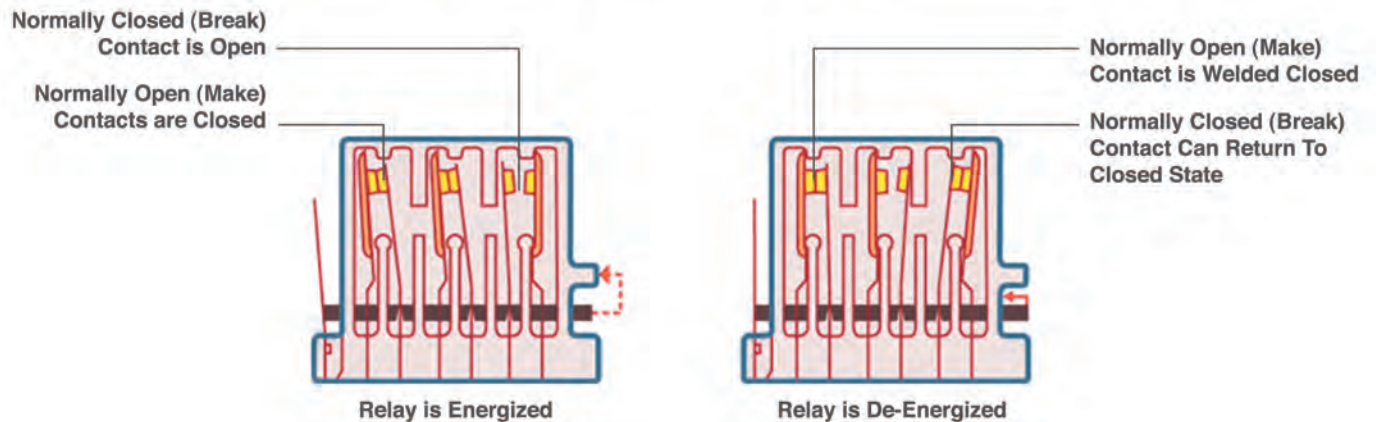

# Relay Terminology

**Flash-Plated:** Thin gold coating of the relay contacts to prevent corrosion during shelf-life (long-time storage).

**Mechanical Life:** Number of expected operation cycles of the relay contacts.

**Mixed Contact Material:** Pertaining to a safety relay on which each single contact can be made of different material, e.g., 6 pole safety relay: 4 n/o contacts made of  $\text{AgSnO}_2 + 0.2\mu\text{mAu}$  and 2 n/c contacts made of  $\text{AgNi } 10 + 5\mu\text{mAu}$ .

**Normally Closed Contact (NC):** A relay contact pair that is closed when the coil is not energized.

**Normally Open Contact (NO):** A relay contact pair that is open when the coil is not energized.

**Nominal Coil Voltage:** The voltage by which the coil is designated and to which certain operating characteristics of the relay are related.

**Operating Voltage:** The voltage by which the relay performs to the desired function.

**Pin Diagram:** A diagram of the points at which a connection is made between the relay and the circuit board.

**Protection Rating:** Classification system for the sealing effectiveness of electrical equipment to protect against foreign bodies. In a two digit code, the first digit indicates the protection against solid objects, while the second indicates protection from moisture.

**International Protection (IP, according to IEC 529):** Protection against a process whereby unwanted material enter the relay to occupy space that would otherwise remain free of such material.

**RTII solder line proof, First digit 4:** Protection from entry by solid objects with a diameter greater than 1.0 mm. Second digit 0: no special protection against moisture

**RTIII wash proof, First digit 6:** Dust-tight. Second digit 7: Protection against immersion.

**Relay Operate Time:** The time interval from coil energization to the functioning time of the last contact to function.

**Relay Release Time:** The time interval from coil de-energization to the functioning time of the last contact to function.

**Safety Relay:** An electro-mechanical relay with forced-guided contacts used in Safety Devices such as Emergency Stop Modules, Safety Gate Monitors, 2-Hand Safety Modules, Safety Light Curtains, etc.

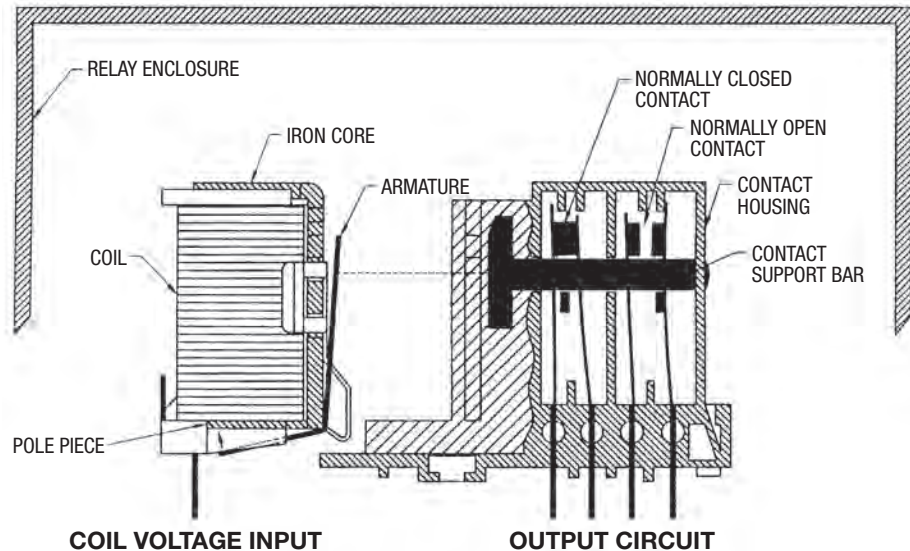

**Switching Current:** The value of the root-mean-square (rms) symmetrical current expressed in amperes, which the relay output contact interrupts at the rated maximum voltage and rated frequency.

**Switching Power:** The value of the product of switching voltage x switching current, which the relay output interrupts under certain test conditions.

**Switching Voltage:** The value of the voltage expressed in volt, which the relay output contact interrupts at the rated maximum current and rated frequency.

**Voltage Range:** The region between the lower and upper limits in regards of the Nominal Coil Voltage.

**Washable:** A sealed construction allows automatic washing and cleaning of the PC board.



Part Number.....Page

156.OA01. \_ \_ \_ C.....34-35  
 156.OA02. \_ \_ \_ C.....38-39  
 156.OA03. \_ \_ \_ C.....40-41  
 156.OA11. \_ \_ \_ C.....32-33  
 156.OA12. \_ \_ \_ C.....36-37  
 256.OA01. \_ \_ \_ C.....34-35  
 256.OA02. \_ \_ \_ C.....38-39  
 256.OA11. \_ \_ \_ C.....32-33  
 256.OA12. \_ \_ \_ C.....36-37  
 456.OA01. \_ \_ \_ C.....34-35  
 456.OA02. \_ \_ \_ C.....38-39  
 456.OA11. \_ \_ \_ C.....32-33  
 456.OA12. \_ \_ \_ C.....36-37  
 56.5601.01.....42  
 56.5601.10.....42  
 56.5602.02.....42  
 56.5602.20.....42  
 56.5603.03.....42  
 56.5611.11.....42  
 56.5612.12.....42  
 56.5621.21.....42  
 56.5622.22.....42  
 56.5669.00.....42  
 56.5669.99.....42  
 56.5669.DR.....42  
 56.5669.GR.....42  
 56.5669.RE.....42  
 56.5670.70.....42  
 56.OA01. \_ \_ \_ C.....22-23  
 56.OA01. \_ \_ \_ N.....22-23  
 56.OA01. \_ \_ \_ S.....22-23  
 56.OA02. \_ \_ \_ C.....24-25  
 56.OA02. \_ \_ \_ N.....24-25  
 56.OA02. \_ \_ \_ S.....24-25  
 56.OA03. \_ \_ \_ C.....26-27  
 56.OA03. \_ \_ \_ N.....26-27  
 56.OA03. \_ \_ \_ S.....26-27  
 56.OA11. \_ \_ \_ C.....18-19  
 56.OA11. \_ \_ \_ N.....18-19  
 56.OA11. \_ \_ \_ S.....18-19  
 56.OA12. \_ \_ \_ C.....20-21  
 56.OA12. \_ \_ \_ N.....20-21  
 56.OA12. \_ \_ \_ S.....20-21  
 56.OA21. \_ \_ \_ C.....10-11  
 56.OA21. \_ \_ \_ N.....10-11  
 56.OA21. \_ \_ \_ S.....10-11  
 56.OA21S. \_ \_ \_ C.....10-11  
 56.OA21S. \_ \_ \_ N.....10-11  
 56.OA21S. \_ \_ \_ S.....10-11  
 56.OA22. \_ \_ \_ C.....12-13  
 56.OA22. \_ \_ \_ N.....12-13  
 56.OA22. \_ \_ \_ S.....12-13  
 56.OA22S. \_ \_ \_ C.....12-13

Part Number.....Page

56.OA22S. \_ \_ \_ N.....12-13  
 56.OA22S. \_ \_ \_ S.....12-13  
 56.OA23. \_ \_ \_ C.....14-15  
 56.OA23. \_ \_ \_ N.....14-15  
 56.OA23. \_ \_ \_ S.....14-15  
 56.OA23S. \_ \_ \_ C.....14-15  
 56.OA23S. \_ \_ \_ N.....14-15  
 56.OA23S. \_ \_ \_ S.....14-15  
 56.OA42. \_ \_ \_ C.....4-5  
 56.OA42. \_ \_ \_ N.....4-5  
 56.OA42. \_ \_ \_ S.....4-5  
 56.OA43. \_ \_ \_ C.....4-5  
 56.OA43. \_ \_ \_ N.....4-5  
 56.OA43. \_ \_ \_ S.....4-5  
 56.OA44. \_ \_ \_ C.....4-5  
 56.OA44. \_ \_ \_ N.....4-5  
 56.OA44. \_ \_ \_ S.....4-5  
 56.OA67. \_ \_ \_ C.....16-17  
 56.OA67. \_ \_ \_ N.....16-17  
 56.OA67. \_ \_ \_ S.....16-17  
 56.OA67S. \_ \_ \_ C.....16-17  
 56.OA67S. \_ \_ \_ N.....16-17  
 56.OA67S. \_ \_ \_ S.....16-17  
 56.OA69. \_ \_ \_ C.....6-7  
 56.OA69. \_ \_ \_ N.....6-7  
 56.OA69. \_ \_ \_ S.....6-7  
 56.OA70. \_ \_ \_ C.....8-9  
 56.OA70. \_ \_ \_ N.....8-9  
 56.OA70. \_ \_ \_ S.....8-9  
 56.OW69. \_ \_ \_ C.....6-7  
 56.OW69. \_ \_ \_ N.....6-7  
 56.OW69. \_ \_ \_ S.....6-7  
 56.OW70. \_ \_ \_ C.....8-9  
 56.OW70. \_ \_ \_ N.....8-9  
 56.OW70. \_ \_ \_ S.....8-9  
 8923.2C.....30-31  
 8923.2N.....30-31  
 8923.2S.....30-31  
 8923.3C.....30-31  
 8923.3N.....30-31  
 8923.3S.....30-31  
 8924.2C.....30-31  
 8924.2N.....30-31  
 8924.2S.....30-31  
 8924.4C.....30-31  
 8924.4N.....30-31  
 8924.4S.....30-31  
 8926.2C.....30-31  
 8926.2N.....30-31  
 8926.2S.....30-31  
 8926.3C.....30-31  
 8926.3N.....30-31  
 8926.3S.....30-31

Part Number.....Page

8927.2C.....30-31  
 8927.2N.....30-31  
 8927.2S.....30-31  
 8927.3C.....30-31  
 8927.3N.....30-31  
 8927.3S.....30-31  
 8949.2C.....28-29  
 8949.2N.....28-29  
 8949.2S.....28-29  
 8949.3C.....28-29  
 8949.3N.....28-29  
 8949.3S.....28-29  
 8951.2C.....28-29  
 8951.2N.....28-29  
 8951.2S.....28-29  
 8951.3C.....28-29  
 8951.3N.....28-29  
 8951.3S.....28-29  
 8955.2C.....28-29  
 8955.2N.....28-29  
 8955.2S.....28-29  
 8955.3C.....28-29  
 8955.3N.....28-29  
 8955.3S.....28-29  
 8956.2C.....28-29  
 8956.2N.....28-29  
 8956.2S.....28-29  
 8956.3C.....28-29  
 8956.3N.....28-29  
 8956.3S.....28-29  
 8963.2C.....28-29  
 8963.2N.....28-29  
 8963.2S.....28-29  
 8972.2C.....28-29  
 8972.2N.....28-29  
 8972.2S.....28-29

# Standard Terms and Conditions of Sale

**TITLE** - Title to the products of ALTECH shall remain with ALTECH until payment is made in full by Customer. Such reservation of title is for the purpose of securing the purchase price and shall not relieve Customer of the duty to inspect the products upon receipt, to notify ALTECH of any deficiencies or defects, and to exercise due care in the use, installation, operation, and maintenance of the products when on the premise of the Customer or under the control of the Customer. Notwithstanding any reservation of title by ALTECH, risk of loss shall pass to customer at any time of shipment.

**SHIPMENT AND DELIVERY** - All orders for destination in the mainland United States (less Hawaii, Alaska and non-continental United States possessions) will be shipped F.O.B. Flemington, N.J. All --destination, shipping and other charges shall be paid by the Customer in accordance with ALTECH's then current shipping and billing practices.

Delivery dates given in the acceptance of any order are approximate. ALTECH shall not be liable for delays in delivery or in performance due to causes beyond its reasonable control including acts of God, acts of Customer, acts of civil or military authority, fires, strikes or other labor disturbances, war, riot or delays in transportation. In the event of such delay, the date of delivery or performance shall be extended for a period equal to the time lost by reason of the delay.

**PRICE** - PRICES in any ALTECH publication are subject to change without prior notification. Catalog prices are based on prices published in the current price list. All written quotations are valid for thirty (30) days from the date of quotation. Customer shall pay all sales, use, excise or similar taxes whenever ALTECH must itself pay and/or collect such tax from Customer arising out of the sale.

**PAYMENT** - Customer agrees to make payment within thirty (30) days of date of the invoice from ALTECH. Customer agrees to pay a late payment charge of one and one-half percent (1.5% per month, or the maximum late payment charge permitted by applicable law, whichever is less, on any unpaid amount for each calendar month (or fraction thereof) that such payment is in default. Orders amounting to less than \$100.00 will be billed at \$100.00 plus freight. Full carton purchases are required. In the event of referral to an attorney for collection, reasonable attorney's fees for collection of the overdue amount shall be paid by Customer. In the event payment is not received within 30 days from the date of invoice, any discount shall be cancelled and the full list price will be due.

**LIMITED WARRANTY** - ALTECH warrants to Customer that the equipment purchases shall be free from defects in material and workmanship under normal use and service for a period of one year from shipment.

Written notice as an explanation of the circumstances of any claim that the equipment has proved defective in material or workmanship shall be given promptly by the Customer to ALTECH.

ALTECH will not be liable for any misuse, improper operations, improper installation, improper maintenance, alteration, modification, accident or unusual degradation of the equipment or parts due to an unsuitable installation environment.

No representation of other affirmation of facts, including but not limited to statements regarding capacity, suitability for use or performance of the equipment, shall be or be deemed to be a warranty or representation by ALTECH for any purpose, nor give rise to any liability or obligation of ALTECH whatsoever.

Customer's sole and exclusive remedy in the event of breach of warranty, as set forth herein, is expressly limited to (1) the correction of the defect by adjustment, repair, modification, or replacement, or (2) issuance of a credit or refund of the purchase price for the defective equipment at ALTECH's election and sole expense.

EXCEPT AS SPECIFICALLY PROVIDED IN THIS AGREEMENT, THERE ARE NO OTHER WARRANTIES EXPRESSED OR IMPLIED INCLUDING BUT NOT LIMITED TO ANY IMPLIED WARRANTIES OR MERCHANTABILITY OR FITNESS FOR A PARTICULAR PURPOSE.

THIS WARRANTY EXTENDS ONLY TO THE CUSTOMER FROM ALTECH OR ITS AUTHORIZED DISTRIBUTOR.

**LIMITATION OF LIABILITY** - IN NO EVENT, SHALL ALTECH BE LIABLE FOR LOSS OF PROFITS, INDIRECT, SPECIAL, CONSEQUENTIAL OR OTHER SIMILAR DAMAGES ARISING OUT OF ANY BREACH OF THIS AGREEMENT OR OBLIGATIONS UNDER THE AGREEMENT.

ALTECH SHALL NOT BE LIABLE FOR ANY DAMAGES CAUSED BY DELAY IN SHIPMENT, INSTALLATION OR FURNISHING OF EQUIPMENT OR SERVICES UNDER THIS AGREEMENT.

No action arising out of any claimed breach of this Agreement may be brought by either party more than two (2) years after the cause of action has accrued.

**PATENT INDEMNITY** - ALTECH shall defend or settle any suit or proceeding brought against Customer based on a claim that any equipment made to ALTECH design and furnished hereunder constitutes an infringement of any existing United States patent, provided (ALTECH) is notified promptly in writing and is given complete authorization and information required for the defense, and ALTECH shall pay all damages and costs awarded against Customer, but shall not be responsible for any costs, expense or compromise incurred or made by Customer without ALTECH's prior written consent. If any equipment is in ALTECH's opinion likely to or does become the subject of a claim for patent infringement, ALTECH may at its option and expense procure for Customer the right to continue using the device, modify it to become non-infringing, but in the event ALTECH is not reasonably able to modify, substitute, or otherwise procure for Customer the right to continue using it, ALTECH will remove such equipment and refund to Customer the amount paid in excess of a reasonable rental for past use.

ALTECH shall not be liable for any infringement or claim based upon use of the equipment in combination with other equipment not supplied by ALTECH or with modifications made by Customer.

The foregoing states the entire liability of ALTECH to Customer arising from patent infringement.

**SELLER'S REMEDIES** - Should Customer fail to make any payment within ten (10) days of its due date, or fail to perform any other of the Customer's obligation hereunder upon thirty (30) days written notice, or should Customer be or become insolvent or be a party to any bankruptcy receivership proceeding prior to full payment of all amounts payable hereunder, ALTECH may: (a) with or without demand or notice to customer declare the entire amount unpaid immediately due and payable; (b) enter upon the premises where the equipment may be found and remove it (Customer shall assemble the equipment and make it available to ALTECH at a place reasonably convenient to both parties and shall permit and assist ALTECH in effecting the retaking and removal of the equipment); and (c) sell any or all the equipment as permitted under applicable law, applying the proceeds of the sale to payment of the expenses of retaking, repairing and selling the equipment, reasonable attorney fees and to the satisfaction of all indebtedness then due and unpaid under this Agreement. Any surplus shall be paid to Customer and any deficiency shall be paid to ALTECH by Customer.

The remedies provided herein shall be cumulative and in addition to all other remedies provided by law or equity or under the Uniform Commercial Code.

**GOVERNING LAW** - This agreement will be governed by the Laws of the State of New Jersey.

**GENERAL** - This Agreement shall only become effective and binding when either (a) it has been accepted and executed by an authorized representative of ALTECH, or (b) the equipment has been shipped to Customer, with or without acceptance in writing hereon. Notice of acceptance is hereby waived by Customer. Customer hereby acknowledges receipt of a true and complete copy hereof.

No addition to or modification of any of the Terms and Conditions of Sale as they appear herein shall be binding upon ALTECH unless signed in writing by duly authorized representative of ALTECH in Flemington, N.J.

Typographical and clerical errors in quotations, orders and acknowledgments are subject to correction.

This Agreement is not assignable without the prior written consent of ALTECH. Any attempt to assign any of the rights, duties or obligations of this Agreement without such consent is void.

If any provision or provisions of this Agreement shall be held to be invalid, illegal or unenforceable, the validity, legality and enforceability, of the remaining provisions shall not in any way be affected or impaired thereby.

ALTECH is not responsible for failure to fulfill its obligation under this Agreement due to causes beyond its control, or except as agreed herein.

THE CUSTOMER ACKNOWLEDGES THAT HE HAS READ THE AGREEMENT, UNDERSTANDS IT, AND AGREES TO BE BOUND BY ITS TERMS AND CONDITIONS. FURTHERMORE, THE CUSTOMER AGREES THAT IT IS THE COMPLETE AND EXCLUSIVE STATEMENT OF THE AGREEMENT BETWEEN THE PARTIES, WHICH SUPERSEDES ALL PROPOSALS OR PRIOR AGREEMENTS, ORAL OR WRITTEN, EXPRESSED OR IMPLIED, AND ALL OTHER COMMUNICATIONS BETWEEN THE PARTIES RELATING TO THE SUBJECT MATTER OF THIS AGREEMENT.

# Here are other great catalogs available from Altech!

## Circuit Protection Devices



Altech the market leader in UL508 Manual Motor Controllers/ Miniature Circuit Breakers now introduces UL489 Miniature Circuit Breakers and UL1077 Supplementary Protectors. The UL489 versions are DIN rail mounted, 17.5mm wide, thermal magnetic, 240V, 480Y/277V AC, 50/60Hz, 125 and 250 VDC models, with short circuit interrupt capacity of 10kA, a positive trip indicator, and are line/load reversible. The UL1077 versions are DIN rail mounted, 17.5mm wide, thermal magnetic, 480Y/277V AC, 50/60Hz, a short circuit withstand capacity 10kA, have a positive trip indicator.

Altech Corp.®  
35 Royal Rd., Flemington, NJ 08822  
908-806-9400  
FAX 908-806-9490  
[www.altechcorp.com](http://www.altechcorp.com)

## Industrial Enclosures



Altech offers a broad selection of non-metallic and aluminum Industrial Enclosures to meet your diverse design requirements. Sizes range from 1.97 x 2.05 x 1.38 to 35.43 x 11.81 x 5.59 inches. Materials include polycarbonate, polystyrene, polypropylene, ABS or aluminum. Polycarbonate and aluminum series have been recently expanded. Protection up to IP67 (NEMA 4, 4X). Smooth sidewalls or sidewalls with knockouts. Enclosures can be mounted directly onto a panel, frame or other mounting surfaces. EMI / RFI Coating is available. Competitive cover printing is available. Hinge Kits. Customization available.

Altech Corp.®  
35 Royal Rd., Flemington, NJ 08822  
908-806-9400  
FAX 908-806-9490  
[www.altechcorp.com](http://www.altechcorp.com)

## Smart Relays



Supports up to 48 I/Os (32 digital inputs & 16 digital outputs). DST Feature Available. Backlit LCD Screen for display & modification of pre-selected parameters of functional blocks, viewing I/O status and programming on the device. PC software for programming, online & offline simulation, documentation & printing. Designed for use in automation for commercial & Industrial sectors. Modbus Communication. UL 508 (UL File No. E352868), IEC 61000-3-2 and IEC 61000-4-2-1~11. 250 lines of ladder programming. 16 soft text messages, Time Switches, Compare Counters, Timers, Counters & 12 analog functions.

Altech Corp.®  
35 Royal Rd., Flemington, NJ 08822  
908-806-9400  
[www.altechcorp.com](http://www.altechcorp.com)

## PCB Spring Clamp & Push-In Terminal Blocks



New spring clamp printed circuit board terminal blocks with push-in technology. Fixed push-in PCB terminals, PCB power terminals push-in, tension spring terminals and push-in plugs.

Altech Corp.®  
35 Royal Rd., Flemington, NJ 08822  
908-806-9400  
[www.altechcorp.com](http://www.altechcorp.com)

## Motor Disconnect Switches



Altech's line of Motor Disconnect Switches are UL 508 listed as Manual Motor Controllers for AC Motor Starting Across-the-line and AC General use. This new 16 page catalog includes the 3 different handle designs, which are all available in gray/black or yellow/red housings. Electrical ratings are 25-150A / 600V. The switches are non-fused DIN Rail mountable. Neat features include: snap-on auxiliary switches, door mounting kit and a retrofit 30A fuse holder. Also featured are Enclosed Motor Disconnect Switches & Fused Enclosed Motor Disconnect Switch (30A) in plastic or stainless housings.

Altech Corp.®  
35 Royal Rd., Flemington, NJ 08822  
908-806-9400  
[www.altechcorp.com](http://www.altechcorp.com)

## Power Supplies



Altech DIN RAIL mountable power supplies have Universal AC input. They are suitable for industrial and automation applications. UL508 Listed or UL Recognized. Single and Three phases up to 960W. Outputs of 5V, 12V, 15V, 24V and 48V. Class 2 devices are available. Installed on DIN rail TS35/ 7.5 or 15. Protections of Short circuit / Overload / Overvoltage / Over temperature. Cooling by free air convection. All-In-One DC-UPS, battery based. Ultra Capacitor DC-UPS, no battery required. Worldwide approvals. 3 year warranty.

Altech Corp.®  
35 Royal Rd., Flemington, NJ 08822  
908-806-9400  
[www.altechcorp.com](http://www.altechcorp.com)

### Altech Search

- Home
- Stock Check
- Distributors
- Information
- News
- Contact
- Rep/Dist Login
- Altech Mexico

- WEB TOOLS**
  - Drawings & Photos
  - Enclosure Finder
  - Altech Videos
  - Request for Quote
  - Sample Request
  - Catalog Request
  - Product Crossings
  - eBook Catalog
- PRODUCT MENU**
  - ATEX Products
  - Circuit Protection/Control >
  - Connectors >
  - Enclosures >
  - Fuses >
  - Digital Panel Meters
  - Foot Switches
  - Interface Modules >
  - Panel Accessories
  - Power Supplies
  - Power Semi-Conductors
  - PCB Connection Technology >
  - Programmable Controllers
  - Standard Switches >
  - Solid State Relays
  - Terminal Blocks >
  - Test & Measurement
  - Tower Lights
  - Timers
  - Wire & Cable Management >
  - Home

## The NEW Altech ENCLOSURE FINDER

Click here to begin

<b>CIRCUIT PROTECTION</b>					
	Circuit Protection Devices		Busbar & Power Distribution		Contactors, Overload Relays, Manual Motor Starters
	Motor Disconnect Switches		European Fuses & Holders		
<b>CONNECTORS</b>			<b>ENCLOSURES</b>		
	Pin & Sleeve Devices		Receptacles		Industrial & ATEX Enclosures
	DIN Enclosures		Control Enclosures and Suspension Systems		
<b>FOOT SWITCHES</b>			<b>MODULES &amp; RELAYS</b>		
	Industrial		Medical		Interface Modules
	Safety Relays		Industrial & Slimline Relays		
<b>PANEL ACCESSORIES</b>		<b>SPARE PARTS</b>		<b>PILOT DEVICES</b>	
	Panel Lights		Heaters, Filters & Thermostats		European Spare Parts
	22 & 30 mm Push Buttons & Enclosures		Pilot Lights & E-Stops		
<b>POWER DEVICES</b>			<b>POWER MANAGEMENT</b>		
	Power Supplies		DC-UPS & Battery Chargers		Altech Smart Relays
	Digital Panel Meters		Digital Timers		
<b>SAFETY SWITCHES</b>					
	Keyed Safety Switches		Keyed Solenoid Locking Switches		Hinged Safety Switches
	Non-Contact Safety Switches		Safety Rope Pull Switches		
<b>STANDARD SWITCHES</b>			<b>SENSORS</b>		
	Limit Switches		Foot Switches		Cylindrical & Capacitive
	Flat Pack & Ring		Metal Detection		
<b>DIN RAIL TERMINAL BLOCKS</b>					
	Screw Clamp Terminal Blocks		Spring Clamp Terminal Blocks		Ring Lug & Stud Terminal Blocks
	Mini & Panel Mount Terminal Blocks		DIN Rail, Mounting Accessories and Markers		
<b>TERMINAL STRIPS</b>		<b>PCB BLOCKS</b>		<b>MARKING</b>	
	Eurostrips™		PCB Terminal Blocks		Marking Tags & Marking Systems
	Custom DIN Assemblies		Custom Enclosures & Modules		
<b>WIRE &amp; CABLE MANAGEMENT</b>			<b>TEST &amp; MEASURE</b>		
<b>TOWER LIGHTS</b>					

Altech Corporation  
 35 Royal Road  
 Flemington, NJ 08822-6000  
 P 908.806.9400 • F 908.806.9490  
 www.altechcorp.com

