

The perfect connection

Connectivity by ABL



International standard power connectors and combination units for trade, construction and industry

Your benefits at a glance

✓ High stress loading capacity

✪ Made of durable and sustainable materials

✓ Convenient to wire

✪ Easy to assemble

🌀 High quality sealing in the cable entry

✪ Wiring space from 1.5 mm² to 2.5 mm²

☁️ UV and media resistant

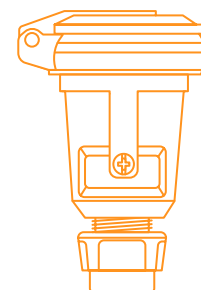
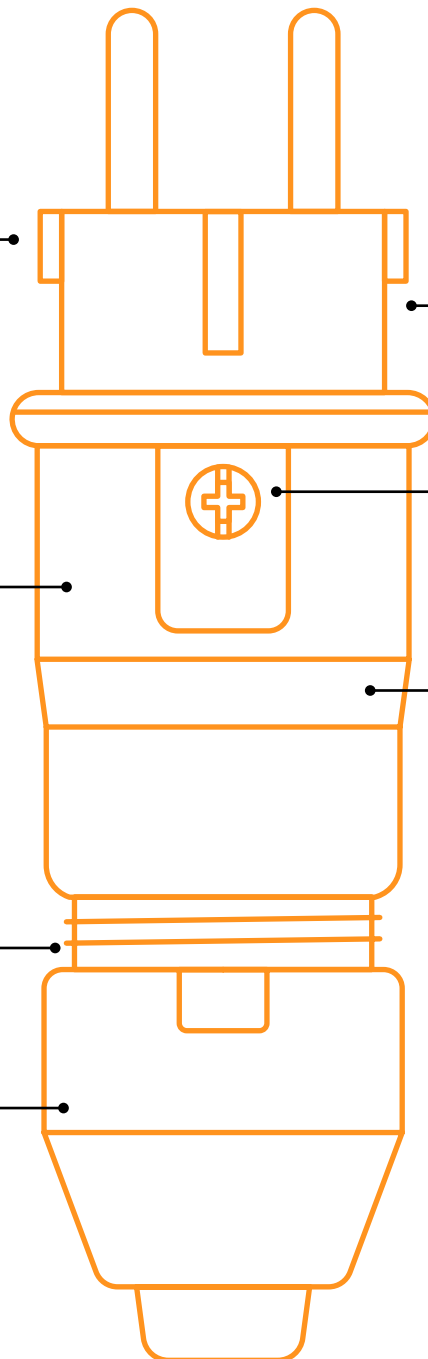

New connector variants

Electrical connecting devices for industry commerce and construction

Electrical connecting devices for industry, commerce and construction

For low mechanical stress such as light hand-held devices and electrical appliances.

Compact

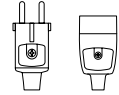

Original

For heavy mechanical stress, e.g. in workshops or trades such as power tools and DIY equipment.

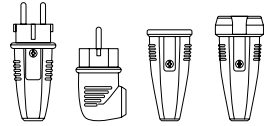

Hightech

For use on construction sites or in agricultural farms.

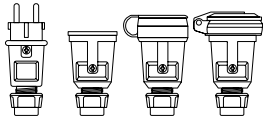

Expert

For heavy mechanical stress, e.g. in workshops or trades.

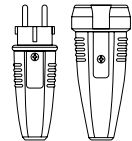

Professional

Specially designed for use in trade or industry.

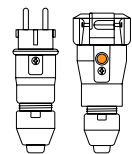

SCHUKO & French/Belgian Standards Compact plugs & connectors





Compact and made of durable materials.
Suitable for indoor use.

 SCHUKO & French/Belgian Standard

 IP20 · IK08

 UV and media resistant

 Wiring space 16awg

 16 A 250 V







SCHUKO & French/Belgian Standards Compact plugs & connectors

Compact plug

 With twin earthing system

 DIN VDE 0620
NF C61-314 · NBN C61-112



Colours	ItemNo.	Standard	g/Unit		Datasheet
● white	10000047	 + 	44		
● grey	10000046	 + 	44		
● black	10000044	 + 	44		

Compact connector

 Without Child Proof

 DIN VDE 0620







Colours	ItemNo.	Standard	g/Unit		Datasheet
● white	10000060		65		
● grey	10000059		65		
● black	10000057		65		

Compact connector

 With Child Proof

 DIN VDE 0620





Colours	ItemNo.	Standard	g/Unit		Datasheet
● white	10000056		66		
● black	10000055		66		
● white	10000063		66		
● grey	10000062		66		
● black	10000061		66		

SCHUKO & French/Belgian Standards Original plugs & connectors



Plug and connector made of durable materials with comfortable grip. Designed for heavy mechanical stress.

 SCHUKO & French/Belgian Standard

 UV and media resistant

 Large wiring space up to 2.5 mm²

 16 A 250 V



SCHUKO & French/Belgian Standards Original plugs & connectors

Original angle Plug



- With twin earthing system
- IP44 IK08
- 2-fold lamellar seal
- DIN VDE 0620
NF C61-314 · NBN C61-112

Colours	ItemNo.	Standard	g/Unit	Datasheet
● black	10000040	+	68	

Original Stecker Original plug



- With twin earthing system
- IP44 IK08
- 3-fold lamellar seal
- DIN VDE 0620
NF C61-314 · NBN C61-112

Colours	ItemNo.	Standard	g/Unit	Datasheet
● schwarz black	10000039	+	68	

Original connector



- Without collar
- IP20 IK08
- 3-fold lamellar seal
- DIN VDE 0620 (SCHUKO)
NF C61-314 · NBN C61-112 (FB)

Colours	ItemNo.	Child Proof	Standard	g/Unit	Datasheet
● schwarz black	10000048	✘		84	
● schwarz black	10000375	✔		84	

Original connector



- With collar
- IP44 IK08
- 3-fold lamellar seal
- DIN VDE 0620 (SCHUKO)
NF C61-314 · NBN C61-112 (FB)

Colours	ItemNo.	Child Proof	Standard	g/Unit	Datasheet
● schwarz black	10000049	✘		86	
● schwarz black	10000376	✔		86	

SCHUKO & French/Belgian Standards Hightech plugs & connectors



Plug and connector made of resilient high-performance plastic Elamid for use under difficult conditions. Connector available in three versions.

⚡ SCHUKO & French/Belgian Standard

◆ Load-capacity up to 1 tonne

☀️ UV and media resistant

🔌 Large wiring space up to 2.5 mm²

🔩 Bolted seal

🛡️ 16 A 250 V

ELAMID ◆

SCHUKO & French/Belgian Standards Hightech plugs & connectors

Hightech plug



⚡ With twin earthing system

🛡️ IP54
IK08

🛡️ DIN VDE 0620
NF C61-314 · NBN C61-112

Colours	ItemNo.	Standard	g/Unit	Datasheet
● black	100000064	+	66	
● red	100000065	+	66	
● blue	100000066	+	66	
● orange	100000067	+	66	

Hightech connector



☐ Without collar

🛡️ IP20
IK08

🛡️ DIN VDE 0620 (SCHUKO)
NF C61-314 · NBN C61-112 (FB)

Colours	ItemNo.	Child Proof	Standard	g/Unit	Datasheet
● black	100000073	✘		79	
● red	100000074	✘		79	
● blue	100000075	✘		79	
● orange	100000212	✘		79	
● black	100000088	✔		79	
● red	100000089	✔		79	
● blue	100000090	✔		79	
● orange	100000213	✔		79	

SCHUKO & French/Belgian Standards Hightech plugs & connectors















Hightech connector

 With collar

 IP44
IK08

 DIN VDE 0620 (SCHUKO)
NF C61-314 · NBN C61-112 (FB)

Colours	ItemNo.	Child Proof	Standard	g/Unit	Datasheet
● black	10000080	✘		101	
● red	10000081	✘		101	
● blue	10000082	✘		101	
● orange	10000083	✘		101	
● black	10000076	✔		101	
● red	10000077	✔		101	
● blue	10000078	✔		101	
● orange	10000079	✔		101	
● black	10000091	✔		101	
● red	10000092	✔		101	
● blue	10000093	✔		101	
● orange	10000094	✔		101	

SCHUKO & French/Belgian Standards Hightech plugs & connectors



Hightech connector

With lid

IP54
IK08

DIN VDE 0620 (SCHUKO)
NF C61-314 · NBN C61-112 (FB)

Colours	ItemNo.	Child Proof	Standard	g/Unit	Datasheet
● black	10000084	✘		116	
● red	10000085	✘		116	
● blue	10000086	✘		116	
● orange	10000087	✘		116	
● black	10000095	✔		116	
● red	10000096	✔		116	
● blue	10000097	✔		116	
● orange	10000098	✔		116	

SCHUKO & French/Belgian Standards Expert plugs & connectors



Plug and connector for highest mechanical stress with ABL quick-release fastening.

 SCHUKO & French/Belgian Standard

 Quick-release fastening

 UV and media resistant

 Large wiring space up to 2.5 mm²

 3-fold lamellar seal

 16 A 250 V

SCHUKO & French/Belgian Standards Expert plugs & connectors

Expert plug

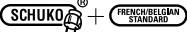

-  With twin earthing system
-  IP44
IK08
-  DIN VDE 0620
NF C61-314 · NBN C61-112

Colours	Item No.	Standard	g / Unit		Data sheet
● black	100000043		78		

Expert connector



-  With collar
-  IP44
IK08
-  DIN VDE 0620
NF C61-314 · NBN C61-112

Colours	Item No.	Standard	g / Unit		Data sheet
● black	100000054		120		

Expert three-way connector



-  With three hinged lids
-  IP20
IK08
-  DIN VDE 0620

Colours	Item No.	Standard	g / Unit	VPE PU	Data sheet
● black	1473190		391	5	

SCHUKO & French/Belgian Standards Expert 3 way connectors

Expert three-way connector
with self-closing lids



-  Voltage indicator
-  IP44 IK08
-  NF C61-314
NBN C61-112

Colours	ItemNo.	Child Proof	Standard	g/Unit		Datasheet
● black	1473597	✔		418		

Expert three-way connector



-  Voltage indicator
-  IP44 IK08
-  NF C61-314
NBN C61-112

Colours	ItemNo.	Child Proof	Standard	g/Unit		Datasheet
● schwarz black	1473292			439		

Expert three-way connector



-  Voltage indicator
-  IP20 IK08
-  NF C61-314
NBN C61-112









Colours	ItemNo.	Child Proof	Standard	g/Unit		Datasheet
● schwarz black	1473692	✔		439		

SCHUKO & French/Belgian Standards Professional plugs & connectors



Plug and connector made of Elamid for use in the craft sector and industry. Particularly robust and resistant due to our unique 2K-technology.



-  SCHUKO & French/Belgian Standard
-  Load-capacity up to 4 tonnes
-  Quick-release fastening
-  IP54 · IK08
-  UV and media resistant
-  Large wiring space up to 2.5 mm²
-  Bolted seal
-  16 A 250 V

SCHUKO & French/Belgian Standards Professional plugs & connectors

Professional plug



With twin earthing system

DIN VDE 0620
NF C61-314 · NBN C61-112

Colours	Item No.	Standard	g / Unit	VPE PU	Data sheet
● rot red	10000069	+	87	5	
● grau grey	10000070	+	87	5	
● schwarz black	10000068	+	87	5	

Professional connector



With self-closing lid

Voltage indicator DIN VDE 0620

Colours	Item No.	Standard	g / Unit		Data sheet
● rot red	100000106		158		
● grau grey	100000107		158		
● schwarz black	100000105		158		

SCHUKO Professional 3 way connector



The SCHUKO Professional three-way connector is made from solid rubber, and equipped with sleeves and self-closing hinged lids.

 SCHUKO

 Splash-proof IP54

 UV and media resistant

 Large wiring space up to 2.5 mm²

 16 A 250 V









SCHUKO Professional 3 way connector

Professional three-way connector



 With self-closing lids





 Voltage indicator  DIN VDE 0620

Colours	Item No.	Standard	g / Unit		Data sheet
 rot red	1173543		418		
 grau grey	1173563		418		
 schwarz black	1173503		418		

US Standard 125VAC/15A Receptacles



Receptables from ABL to North American Standard UL 498/NEMA 5-15 R and to Canadian Standard CSA C22.2 Nr.: 42 are made of high impact thermoplastic and are therefore particularly robust. The socket outlets are resistant to heat, cold and UV radiation. The cable connection is from the rear and the opening angle approx. 106°.

-  North American Standard
-  IP54 IK08
-  Ambient temperature operation: -25°C bis +40°C
-  Thermoplastic
-  15 A 125 V

US Standard 125VAC/15A Receptacles

Features:

- DIN Rail, Panel Mount or Wall Mount
- Rating: 15A/125V AC
- Finger Protection: IP54
- Available in 3 colors.

Panel Mount	Wall Mount	DIN Rail Mount	Built in DIN Rail Mount
-------------	------------	----------------	-------------------------

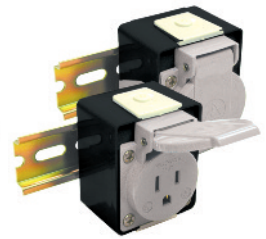
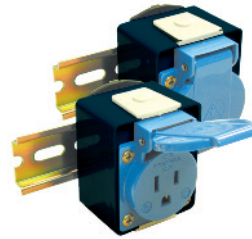
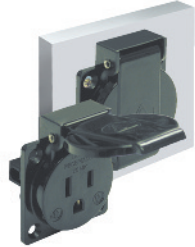

External Dimension (HxWxL mm)	36.5 x 61.5 x 50	50 x 71 x 53.5	58.5 x 84 x 53.5	55 x 84 x 54
Stripping Length	10 mm	10 mm	10 mm	10 mm
Insulation Material	Thermoplastic	Thermoplastic	Thermoplastic	Thermoplastic
Type of Connection	3 screw clamps	3 screw clamps	3 screw clamps	3 screw clamps
Approvals*	US E154664	US E154664	US E154664	US E154664
Voltage Rating	125 V	125 V	125 V	125 V
Current Rating	15 A	15 A	15 A	15 A

Cat. No.	Std. Pk.	Cat. No.	Std. Pk.	Cat. No.	Std. Pk.	Cat. No.	Std. Pk.
----------	----------	----------	----------	----------	----------	----------	----------

Complete Kit:

Blue	PMRBU	1	WMRBU BLACKBOX	1	DMRBU BLACKBOX	1	-	-
Gray	PMRGR	1	WMRGR BLACKBOX	1	DMRGR BLACKBOX	1	DMRGR-M*	1
Black	PMRBA	1	WMRBA	1	DMRBA	1	-	-

Optional Accessory Sealing Gasket for Panel Mount Receptacles	SEALGASK	1	Includes Sealing Gasket	Includes Sealing Gasket	Includes Sealing Gasket
---	----------	---	-------------------------	-------------------------	-------------------------

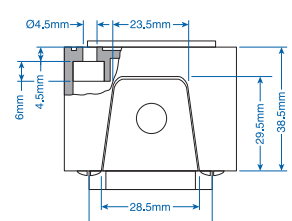
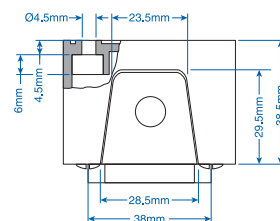
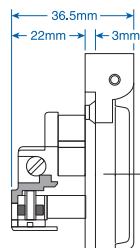
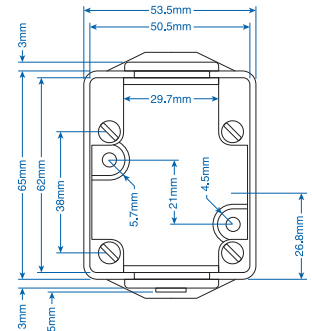
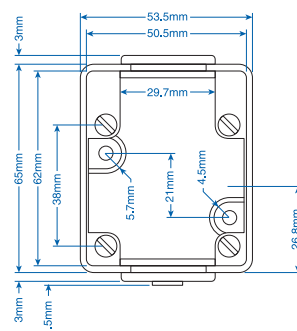
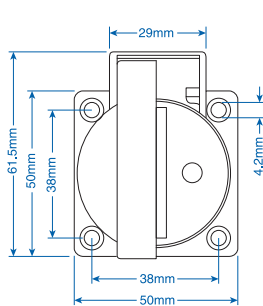

The front socket and hinged protective cover are still available in blue and gray.

UL approval applies to outlet only, not enclosure or DIN rail clip.

* Available in gray only.

PANEL MOUNT

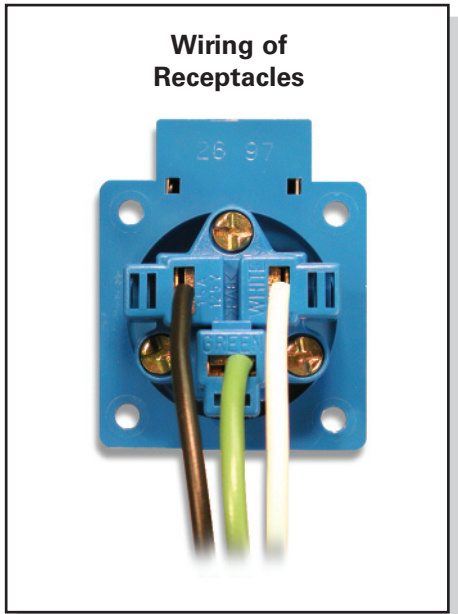
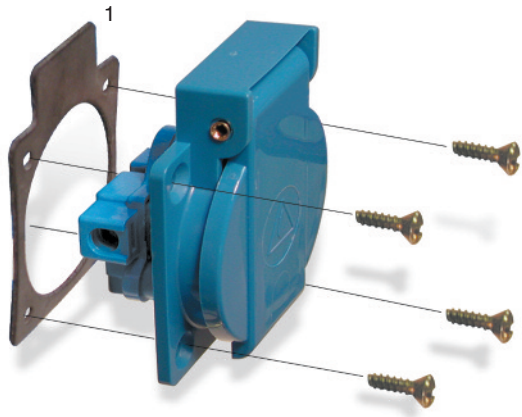

WALL MOUNT

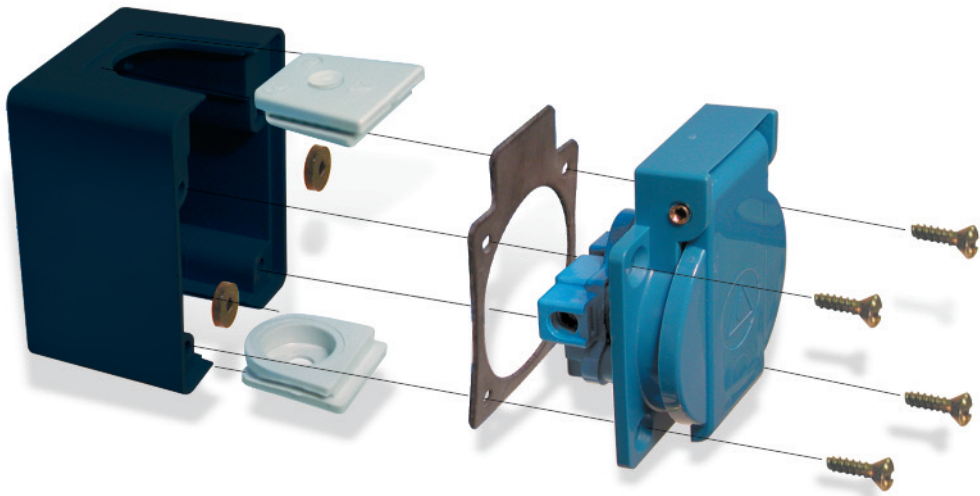

DIN RAIL MOUNT

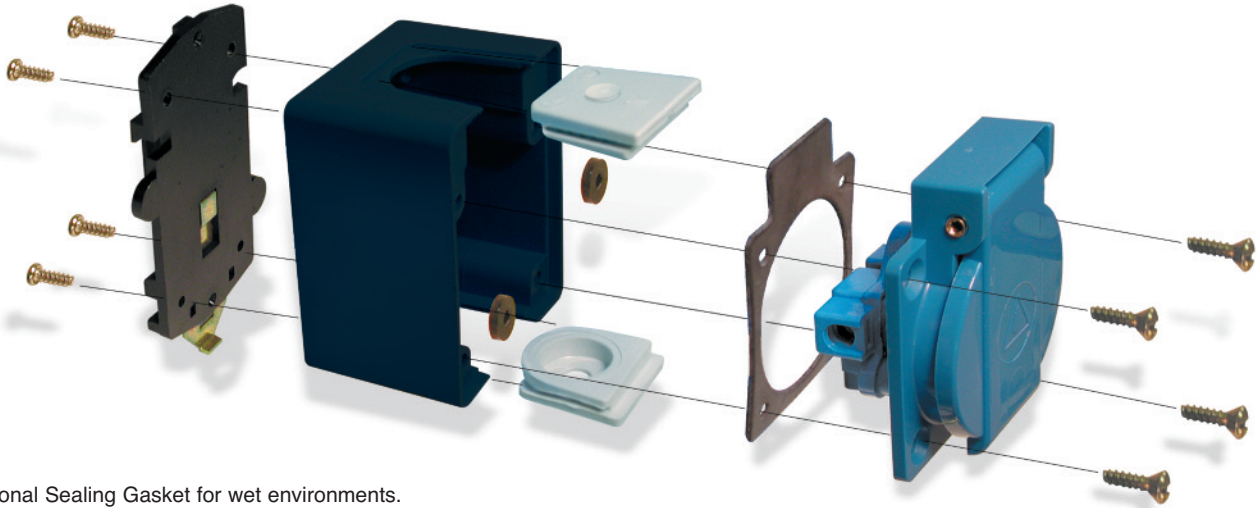







¹ Optional Sealing Gasket for wet environments.

SCHUKO & French/Belgian Standards Receptacles



The SCHUKOplus built-in socket outlet with flanged fixing is made from highly impact resistant thermoplastic, and designed for extremely heavy duty use. SCHUKOplus is perfectly suited to portable applications. Plugged or unplugged – thanks to the integrated rim, SCHUKOplus is always sealed.

-  SCHUKO & French/Belgian Standard
-  UV and media resistant
-  With screw terminals
-  Flush Mounting
-  Impact Resistant Plastic
-  Different colours
-  16 A 250 V



SCHUKO Receptacles

Features:

- DIN Rail, Panel Mount or Wall Mount
- Rating: 16A/250V AC
- Finger Protection: IP20
- Available in 3 colors.

PANEL MOUNT



WALL MOUNT



DIN RAIL MOUNT



External Dimension (HxWxL mm)	46.5 x 61.4 x 50	50 x 71 x 53.5	58.5 x 84 x 53.5
Stripping Length	10 mm	10 mm	10 mm
Insulation Material	Thermoplastic	Thermoplastic	Thermoplastic
Type of Connection	3 screw clamps	3 screw clamps	3 screw clamps
Standard	DIN 49440	DIN 49440	DIN 49440
Voltage Rating	250 V	250 V	250 V
Current Rating	16 A	16 A	16 A

	Cat. No.	Std. Pk.	Cat. No.	Std. Pk.	Cat. No.	Std. Pk.
Complete Kit:						
Blue	PMRBU-GE	1	WMRBU-GE Black Box*	1	DMRBU-GE Black Box*	1
Gray	PMRGR-GE	1	WMRGR-GE Black Box*	1	DMRGR-GE Black Box*	1
Black	PMRBA-GE	1	WMRBA-GE Black Box	1	DMRBA-GE Black Box	1
Optional Accessory Sealing Gasket for Panel Mount Receptacles	SEALGASK	1	Includes Sealing Gasket		Includes Sealing Gasket	

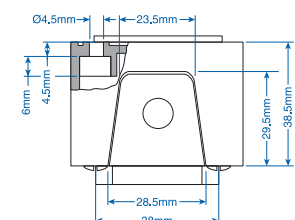
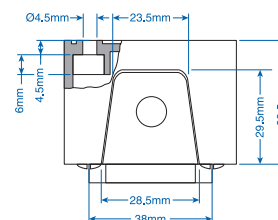
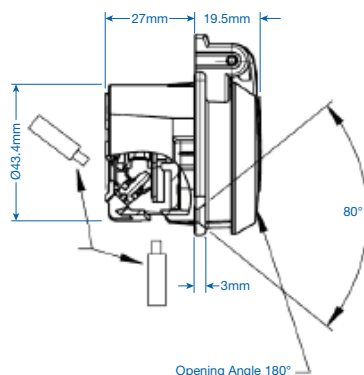
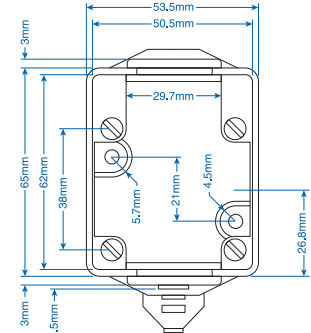
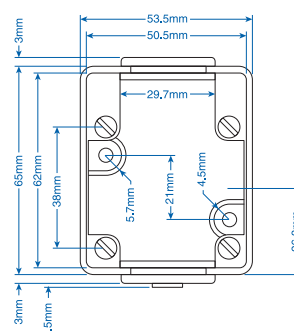
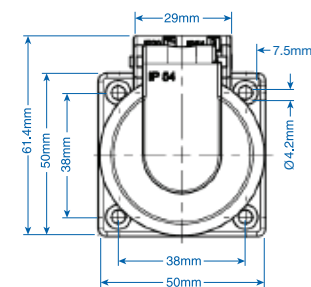

* Please Note:

Matching colored blue and gray assembly enclosures have been discontinued.

The hinged protective covers are still available in blue, gray, and black.

SCHUKO & French/Belgian Standards Receptacles

SCHUKOplus Elamid 2K socket outlet



IP54 IK08
 With seal
 DIN VDE 0620

Colours	ItemNo.	Child Proof	Standard	g/Unit		Datasheet
● blau blue	1561050	✘		53		
● rot red	1561040	✘		53		
● gelb yellow	1561030	✘		53		
● grau grey	1561060	✘		53		
● blau blue	1562050	✔		55		

Thermoplastic socket outlet without lid



IP20 IK08
 DIN VDE 0620

Colours	ItemNo.	Standard	g/Unit		Datasheet
● schwarz black	1661300		38		
● blau blue	1661350		38		
● grau grey	1661360		38		

Thermoplastic socket outlet French/Belgain Standard



With self-closing lid
 IP54 IK08
 NF C61-314 NBN C61-112

Colours	Item No.	Child Proof	Standard	g/Unit	PU	Data sheet
● blau blue	1662052	✔		38	100	
● grau grey	1662062	✔		38	100	

Accessories for Receptacles

Thermoplastic surface-mounted housing



● For socket outlets 1561, 1562, 1662

 IP54

Item No.	g/Unit	Data sheet
1461007	49	

DIN Rail Mounting plate



● Surface-mounted housing for snapping onto DIN rail acc. to DIN EN 60715 35 mm

Item No.	g/Unit	Data sheet
1461SB	14	

