

REVISIONS FOR DWG # 3EN-3IS-AL-AL1006\_3

REV	CH.NO.	DESCRIPTION	DATE	REVISED BY
-	-	ORIGINAL DESIGN	08/01/11	ROLAND G

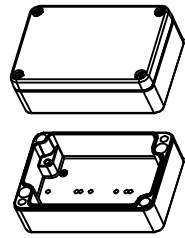

1:2

SECTION B-B

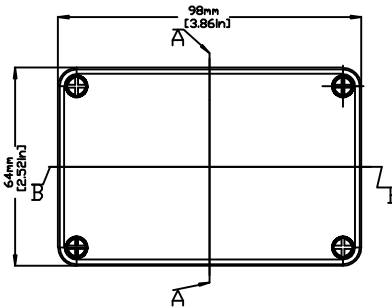
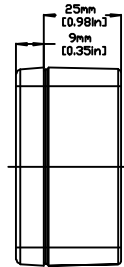
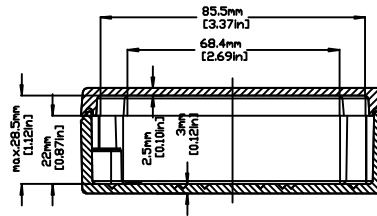

SECTION C-C

SECTION A-A

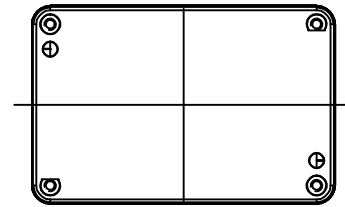
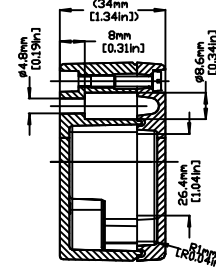
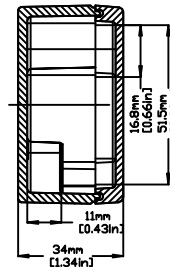

BOTTOM VIEW

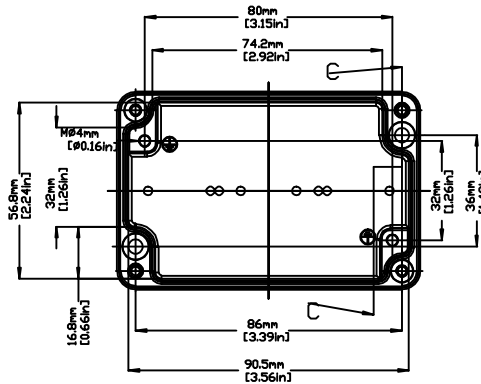

TOP VIEW WITHOUT LID

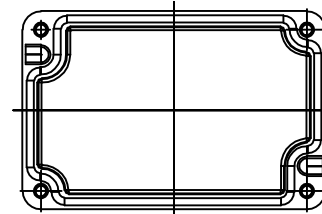

INTERIOR VIEW OF LID

UNLESS OTHERWISE SPECIFIED  
 • ALL DIMENSIONS ARE IN MILLIMETERS  
 • THIRD ANGLE PROJECTION

TOLERANCE	
XX	± XX mm
XX.X	± XX mm
XX.XX	± XX mm
ALL	± XX mm

FIRST

This Drawing is the property of

**Altrech Corp.**

35 Royal Road  
 Flemington NJ 08822-6000  
 (908) 806-9400 • Fax (908) 806-9490

AND IS A CONFIDENTIAL DISCLOSURE LENT WITHOUT CONSIDERATION OTHER THAN THE BORROWER'S AGREEMENT THAT IT SHALL NOT BE REPRODUCED, COPIED, LENT, OR DISPOSED OF DIRECTLY OR INDIRECTLY NOR USED FOR ANY PURPOSE OTHER THAN THAT FOR WHICH IT IS SPECIFICALLY FURNISHED.

TITLE: ALUMINUM ENCLOSURE  
 AL 1006-3 (150-003)

DRAWN BY: ROLAND GYORGYPAL	08/01/2011	DRAWING NO.:	3EN-3IS-AL-AL1006_3	REV.:	-
CHECKED BY: JEFF ROYE	08/01/2011	SCALE:	-	SHEET:	1 OF: 1
RELEASED BY: LASZLO G.	08/01/2011				