

Float switch

Series Adjustable-Float switch

Description **MAN-VST-R2,0/0650**

Article number **6880121048**

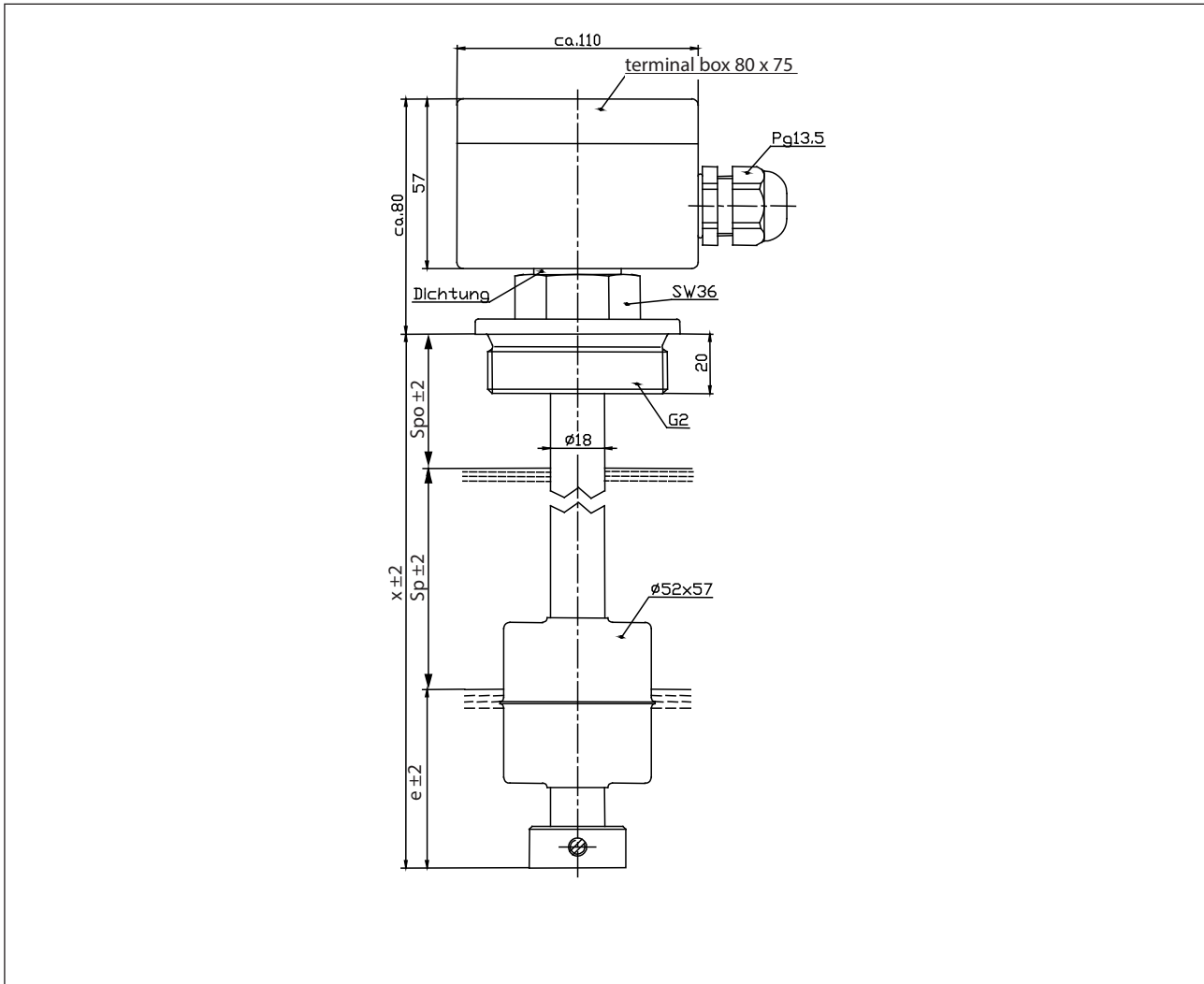

Dimensions

Tube length	x	650 mm
Switching point	Sp	≥ 80 mm
End length	e	≥ 60 mm
Top switching point	Spo	≥ 70 mm

The Switching points are adjustable in 10 mm increments.

Mechanical data	
Terminal box material	Aluminium coated (RAL 7001)
Bolting materia G2	X 6 CrNiMoTi 17 12 2 (1.4571)
Bolting material Pg13,5	PA
Switching tube material	X 6 CrNiMoTi 17 12 2 (1.4571)
Float material	X 6 CrNiMoTi 17 12 2 (1.4571)
- density	about 0,6 g/cm ³ ±10 %
- depth of immersion	35 mm ± 2 mm (to a fluid-density of 1 g/cm ³)
Gasket material	Klingersil and NBR
Adjusting ring material	X 6 CrNiMoTi 17 12 2 (1.4571)
Ambient air temperature	-5 °C to +100 °C
Liquid temperature	-5 °C to +100 °C
Connection	Connecting block inside the terminal box
Protection type	IP 65 acc to IEC529 / EN 60529
Max. pressure	10 bar

General details
Maximum data must not be exceeded! At assembly the switching modules the requirements according to DIN VDE 100 are to be observed.

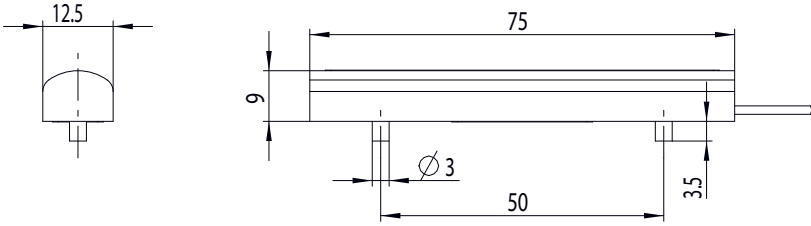
Accessories (not included)	
	
Switching module	N.C. / N.O. – position dependent Changeover switch
<ul style="list-style-type: none"> • 4910007069 • 4916007075 	
Number of possible switching modules	Depends on the fitting length x (see page 1), but max. 4 switching modules.