

# Technical Data

## Float Switch

### Standard float switches

Description **MAB-723 LVS 0250**

Article number **6826141026**

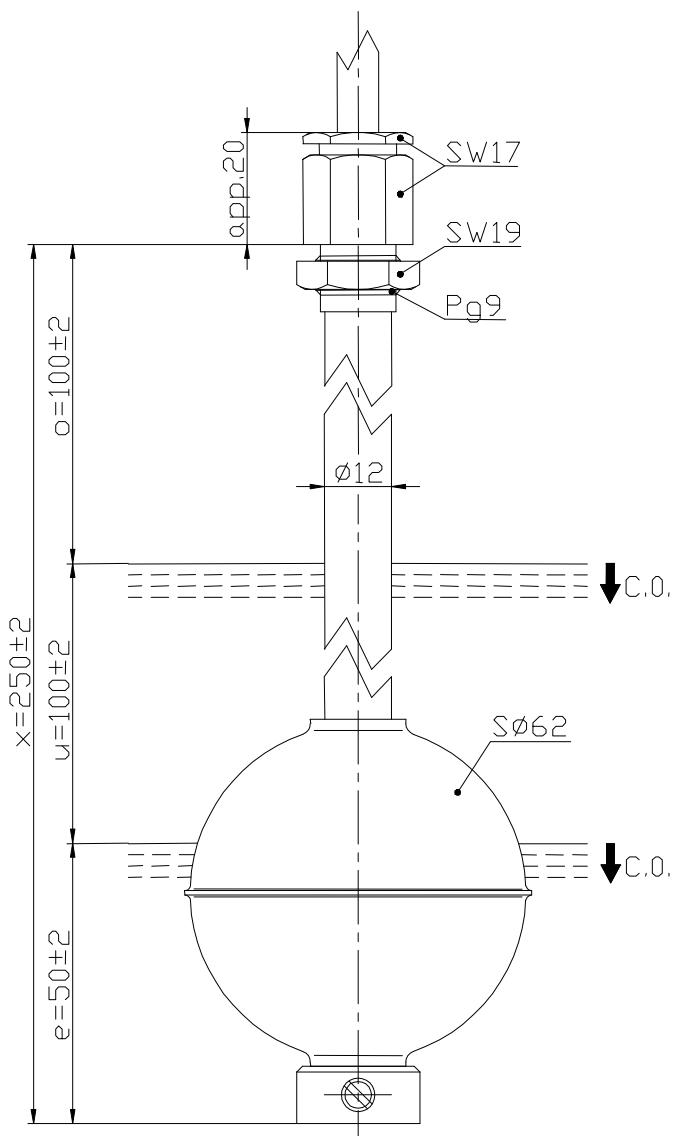

### Performance diagram (maximum data)

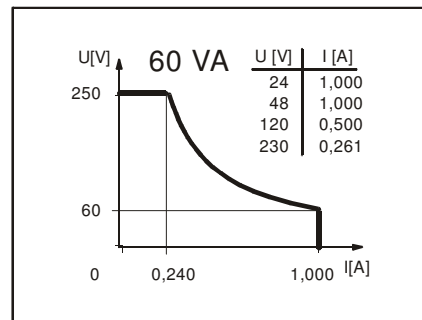

### Wiring diagram (matching to the drawing)

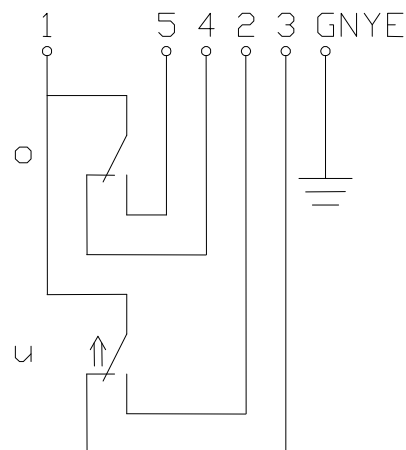

Subject to change without notice.

Date of issue : 24.03.2009 / Page 1 of 2  
Document : 6826141026\_01\_en.doc / Last update : 1

### Standard float switches

Description **MAB-723 LVS 0250** Article number **6826141026**

#### Electrical data

Reed contact	max. switching voltage	250 V
	max. switching current	1,0 A
	max. switching capacity	60 VA
	mechanical life	10 <sup>7</sup> to 10 <sup>9</sup> switches depending on the load
Switching element		2 change over contact, falling level
Direction category		AC-21A and DC-21A acc. to DIN VDE 0660 T107
Standard		acc. to DIN VDE 0660 T200

#### Mechanical data

Female material	X6CrNiMoTi17-12-2 (1.4571)
Screw connection material	X2CrNiMo17-12-2 (1.4404)
Hexagon nut material	X6CrNiMoTi17-12-2 (1.4571)
Switching tube material	X6CrNiMoTi17-12-2 (1.4571)
Float material	X6CrNiMoTi17-12-2 (1.4571)
-density	about 0,52 g/cm <sup>3</sup> ±10%
-depth of immersion	33 mm ±2 mm ( to a fluid-density of 1 g/cm <sup>3</sup> )
Adjusting ring material	X6CrNiMoTi17-12-2 (1.4571)
Gasket material	X6CrNiMoTi17-12-2 (1.4571)
Ambient air temperature	-5°C to +60°C
Liquid temperature	-5°C to +60°C
Connection	4m cable, PVC, 6x0.5mm <sup>2</sup>
Protection type	IP 65 acc. to DIN VDE 0470 T1
Max. pressure	10 bar

#### General details

Repeatability of switching points is ±0,05mm based on the same geometrical conditions as of a switch device.  
The measures of the switching points refer to a fluid-density of 1 g/cm<sup>3</sup>.  
The tolerance of the switching points is ±2mm  
Pay attention to the contact protection, when switching inductive loads. Maximum data must not be exceeded!