

Technical Data

Float Switch

Standard float switches

Description **MAB-713 LHS 0125**

Article number **6816151004**

Wiring diagram

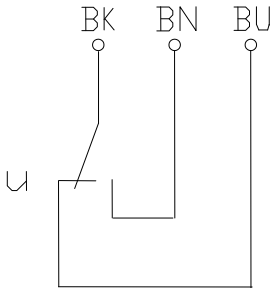

Performance diagram

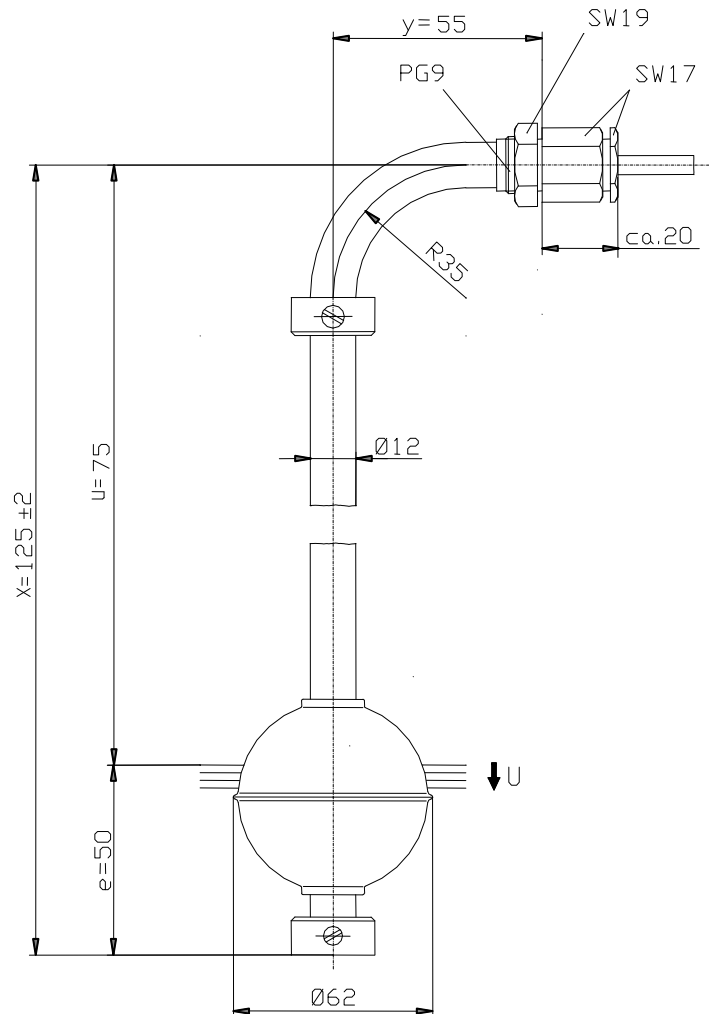
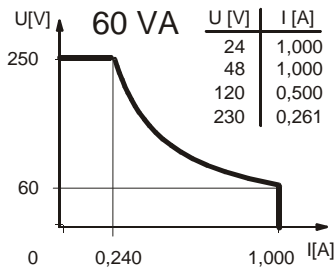

Characteristic features in accordance with EN 60947-5-1

Electrical data

max. switching voltage	250 V
max. switching current	1,0 A
max. switching capacity	60 VA
min. switching capacity	3 VA
mechanical life	10^7 to 10^9 switches depending on the load
Switching element	1 x change-over contact, falling level
Protection class	II (protective insulation)

This document will not become the contractual basis; the details included herein do not constitute any descriptions of expected conditions, so that warranties/claims for defects on account of possible variations of the actual qualities from the qualities described herein are explicitly excluded. All rights reserved. Specifications subject to change without notice!

Date of issue : 06.11.2013 / Page 1 of 2
Document : 6816151004_en / Last update : 1 / 6675-13

Mechanical data

Screw connection material	X6CrNiMoTi17-12-2 (1.4571)
Hexagon nut material	X6CrNiMoTi17-12-2 (1.4571)
Switching tube material	X6CrNiMoTi17-12-2 (1.4571)
Float material	X6CrNiMoTi17-12-2 (1.4571)
-density	about 0,6 g/cm ³ ±10%
-depth of immersion	34 mm ±2 mm (to a fluid-density of 1 g/cm ³)
Adjusting ring material	X6CrNiMoTi17-12-2 (1.4571)
Gasket material	NBR
Ambient air temperature	-5°C to +60°C
Liquid temperature	-5°C to +60°C
Connection	Cable 3x0,5 mm ² x 4 m ± 5 %, PVC
Protection type	IP 65 acc to IEC529 / EN 60529
Max. pressure	10 bar

EC Conformity

acc. to Directive 2006/95/EC

General details

Repeatability of switching points is ±0,05mm based on the same geometrical conditions as of a switch device.

The measures of the switching points refer to a fluid-density of 1 g/cm³.

The tolerance of the switching points is ±2mm

Pay attention to the contact protection, when switching inductive loads. Maximum data must not be exceeded!

Inductive loads

Direct current

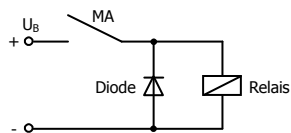

Suppression of voltage peaks with a free-wheeling diode

Alternating voltage

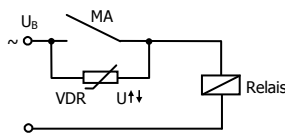

Suppression of voltage peaks with a VDR

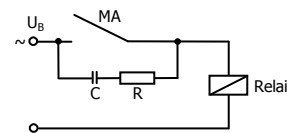

Suppression of voltage peaks with an RC element

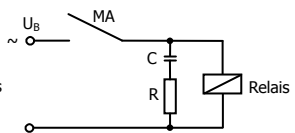

Capacitive loads and lamp loads

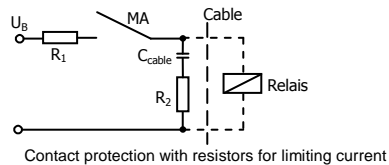

Contact protection with resistors for limiting current

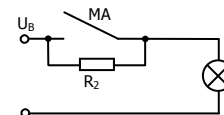
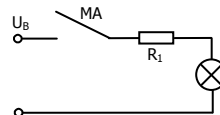

This document will not become the contractual basis; the details included herein do not constitute any descriptions of expected conditions, so that warranties/claims for defects on account of possible variations of the actual qualities from the qualities described herein are explicitly excluded. All rights reserved. Specifications subject to change without notice!

Date of issue : 06.11.2013 / Page 2 of 2
Document : 6816151004_en / Last update : 1 / 6675-13