

## Inductive Proximity Switch Series M30

Description **KIN-M30PS/015-KLSD**

Article number **6502935001**

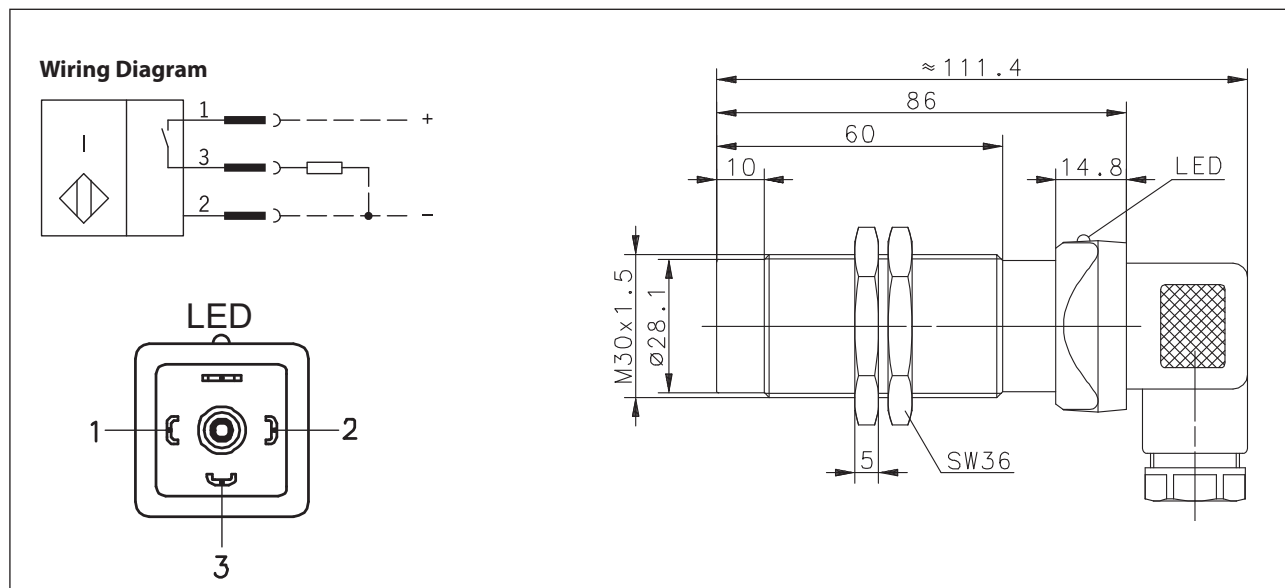

### Identifying characteristics in accordance with EN 60947-5-2

Electrical data		
Rated operating distance	$S_n$	15 mm
Standard target		45 mm x 45 mm, t = 1 mm; Material: FE360
Real sensing distance	$S_r$	13,5 ... 16,5 mm
Assured operating distance	$S_a$	0 ... 12,2 mm
Switching element function		N.O., DC
Repeat accuracy	R	≤ 5 %
Differential travel (hysteresis)	H	≈ 10 %
Operational voltage range	$U_B$	10 - 60 V DC
Rated insulation voltage	$U_i$	75 V DC
Rated impulse withstand voltage	$U_{imp}$	500 V
Voltage drop	$U_d$	≤ 2,5 V
Utilization category		DC-13 at $I_e = 50$ mA and $U_e = 33$ V DC
Rated operational current	$I_e$	200 mA
Off-state current	$I_r$	< 0,1 mA
No-load supply current	$I_o$	< 8 mA
Switching element		Permanent overload and s.c.p.
Short-circuit protection		pulsed
Frequency of operating cycles	f	100 Hz
Mounting		non flush
False polarity protection		yes
Time delay before availability	$t_v$	≤ 50 ms

<b>Electromagnetic compatibility (EMC)</b>	
Electromagnetic field test	IEC 61000-4-3
Electrostatic discharge test	IEC 61000-4-2
Electrical fast transient immunity test	IEC 61000-4-4
Radiated disturbance field strength	EN 55011

<b>Mechanical Data</b>	
Front cap	PA 6.6, black
Enclosure	Brass, nickel plated
End cap	PA 6, black
Ambient air temperature	-25 °C ... +70 °C (plug: -30 °C .... +120 °C)
Type of protection	IP65 (only in fully locked position with it's plugs)
Pollution degree	3 (Pollution of the active zone can cause impairments of the operating distances.)
Indication	LED yellow
Termination type	Connection in dependence on DIN EN 175301-803
For attachment	2 x hexagon nut

<b>EU Conformity</b>	
acc. to directive 2004 / 108 / EC	