

# Safety switch

## Series SGS

Description **SGS-SA2Z AK F3 24V**

Article number **6110888010**

### Operating symbol

Termination electromagnet with contact position

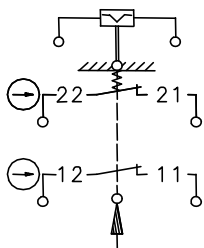

### Operating diagram

(Return by E-magnet)

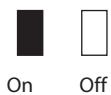
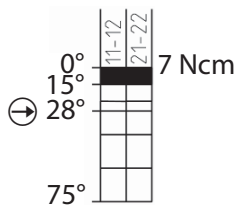

Tolerances:  
Operating point  $\pm 3,5^\circ$ ;  
Operating force  $\pm 30\%$

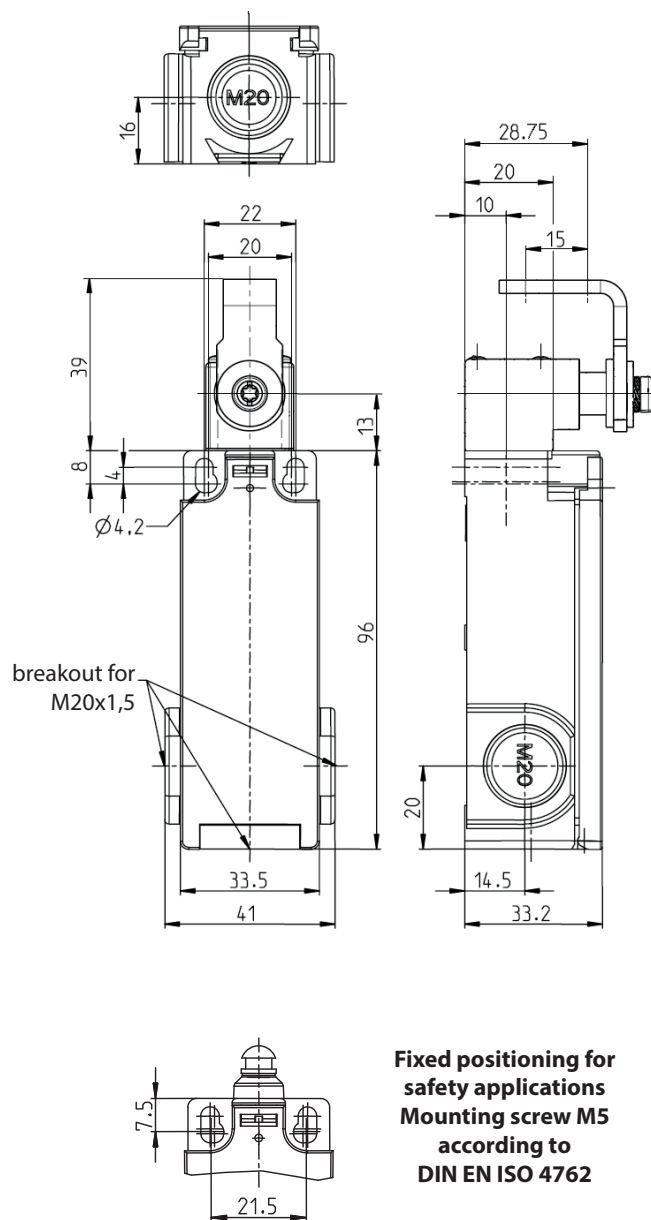

**Fixed positioning for safety applications**  
**Mounting screw M5 according to DIN EN ISO 4762**

<b>Elektrische Daten</b>		
Electrical data	II, totally insulated	
<b>Protection class</b>		
Contact elements	$U_i$	250 V AC
Rated insulation voltage	$I_{the}$	10 A
Conv. thermal current	AC-15, $U_e / I_e$ 240 V / 3 A	
Utilization category	DC-13, $U_e / I_e$ 250 V / 0,27 A	
Min. Voltage	24 V	12 V
Min. Current	5 mA	20 mA
Direct opening action	⊖	according to IEC/EN 60947-5-1, Annex K
Short-circuit protective device	Fuse 4 A gG	
<b>Electro magnets</b>		
without recovery diode		
Temperature class	B (130 °C)	
Rated operational voltage	$U_e$	24 V DC
Operational voltage range	$U_B$	-15 % ≤ $U_e$ ≤ +10 %      +10 % < $U_e$ ≤ +25 %
Rated operational current	$I_e$	2,3 A -15 %      2,3 A -15 %
On-Time	ED	3 %      2 %
Min. On-Time	$T_i$	0,2 s      0,2 s
Max. On-Time	$T_e$	0,5 s      0,5 s
Min. Off-Time	$T_p$	17 s      27 s

<b>Mechanical data</b>	
Enclosure	Thermoplastic GV self-extinguishing
Cover	Thermoplastic GV self-extinguishing
Actuating	Lever arm housing, lever (st)
Velocity for actuating	$V_{max}$ 0,5m/s
Ambient air temperature	-25 °C ... +50 °C
Contact type	2 NC (Zb)
Switching principle	Magnetic snap action, bistable
Mechanical life	5 x 10 <sup>4</sup> operating cycles
Assembly	2 x M4 / 2 x M5 for safety applications
Connection - contact elements	4 screw terminals (M3,5)
Conductor cross-sections	Solid: 0,5 ... 1,5 mm <sup>2</sup> Litz wire with ferrules: 0,5 ... 1,5 mm <sup>2</sup>
Connection - Electro magnets	2x butt connector similar to DIN 46341 (crushing zone 0,5 – 1,5 mm <sup>2</sup> )
Cable entrance	3x M20x1,5 breakout, left, right and upside
Installation position	Operator definable
Contact opening	4 x >2 mm
Protection type	IP65 acc. to IEC/EN 60529

<b>ID for safety engineering</b>	
B10d	1 x 10 <sup>5</sup> cycles

**Actuation**

By loosening the 4 screws the actuation assembly can be rotated in 90 degree increments such that 4 actuation directions are possible. The actuation assembly is to be again fastened to the housing using the 4 screws.

Standards	
	VDE 0660 T100, DIN EN 60947-1, IEC 60947-1
	VDE 0660 T200, DIN EN 60947-5-1, IEC 60947-5-1
	DIN EN ISO 13849-1
	DIN EN 81-1, 81-2; 81-20

EU Conformity	
	acc. to directive 2014/35/EU

Notes	
<p>The degree of protection (IP code) specified applies solely to a property closed cover and the use of an equivalent cable gland with adequate cable.</p> <p>The switch may not be used as a mechanical stop.</p>	