

Plastic bodied limit switch Series IF

Description **IF-A2Z AH**

Article number **6089835013**

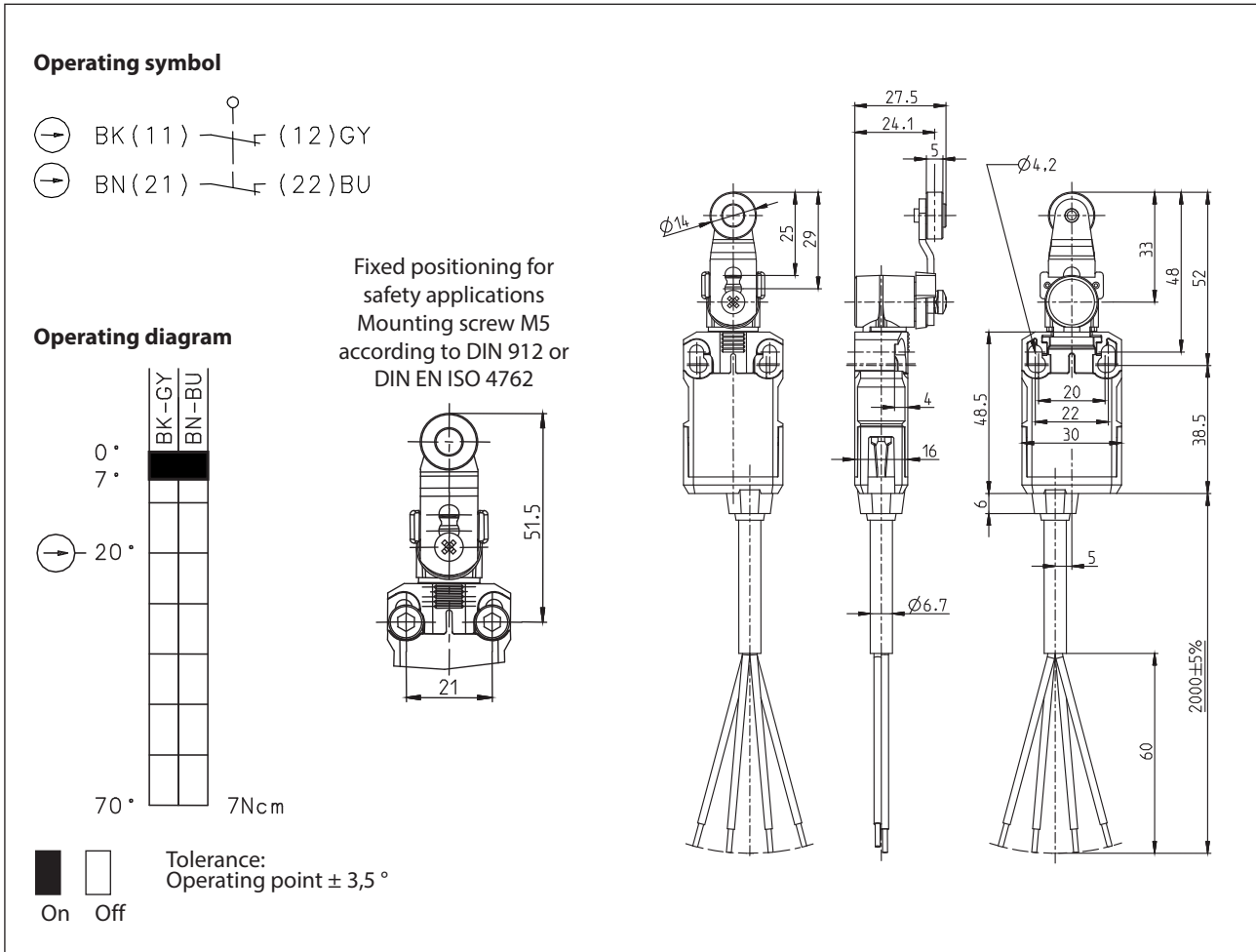

Electrical Data		
Rated insulation voltage	U_i	250 V AC
Conv. thermal current	I_{the}	10 A
Rated operational voltage	U_e	240 V
Utilization category		AC-15, U_e/I_e 240 V / 3 A
Direct opening action		acc. to IEC/EN 60947-5-1, annex K
Short-circuit protective device		Fuse 6 A gG
Protection class		II, totally insulated

