

# Technical Data

## Plastic bodied limit switch

### Series I88

Description **I88-U15Z VKW RE**

Article number **6086100097**

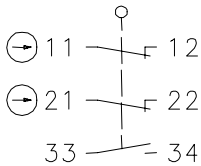

#### Operating symbol

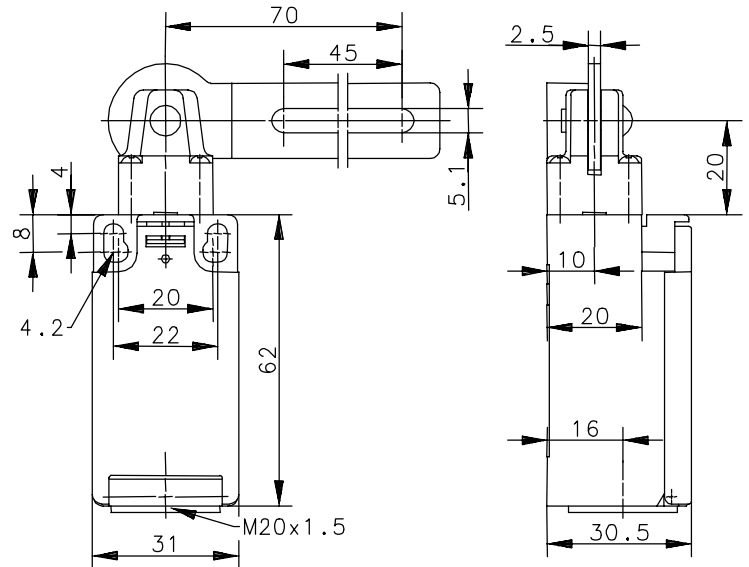
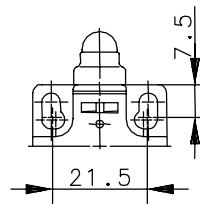
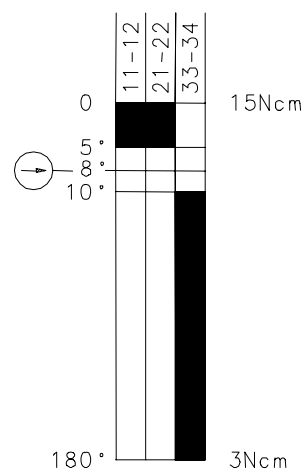

Fixed positioning for safety applications  
Mounting screw according to DIN 912 M5

#### Operating diagram



  Tolerance:  
 On Off Operating point  $\pm 3,5^\circ$ ;  
 Operating torque  $\pm 10\%$

#### Electrical data

Rated insulation voltage	$U_i$	250V AC
Conv. thermal current	$I_{the}$	5A
Rated operational voltage	$U_e$	240V
Utilization category		AC-15, $U_e/I_e$ 240V/1,5A
Direct opening action		acc. to IEC/EN 60947-5-1, Annex K
Short-circuit protective device		Fuse 6A gL/gG
Protection class		II, totally insulated

This document will not become the contractual basis; the details included herein do not constitute any descriptions of expected conditions, so that warranties/claims for defects on account of possible variations of the actual qualities from the qualities described herein are explicitly excluded. All rights reserved. Specifications subject to change without notice!

# Technical Data

## Plastic bodied limit switch

<b>Mechanical data</b>	
Enclosure	Thermoplastic, glass fibre reinforced (UL 94-V0)
Cover	Thermoplastic, glass fibre reinforced (UL 94-V0)
Actuator	Lever (metal)
Ambient air temperature	-30°C ... +80°C
Contact type	2 NC, 1 NO (Zb)
Mechanical life	1 x 10 <sup>6</sup> switching cycles
Switching frequency	≤ 50/min
Assembly	2 x M4
Connection	4 screw connections (M3,5)
Conductor cross-sections	Solid: 0,5 ... 1,5mm <sup>2</sup> Litz wire with ferrules: 0,5 ... 1,5mm <sup>2</sup>
Cable entrance	1 x M20x1,5
Weight	≈ 0,09kg
Installation position	Operator definable
Protection type	IP65 acc. to EN 60529; DIN VDE 0470 T1
<b>Standards</b>	VDE 0660 T100, DIN EN 60947-1, IEC 60947-1 VDE 0660 T200, DIN EN 60947-5-1, IEC 60947-5-1
<b>EU Conformity</b>	<b>CE</b>
<b>Approvals</b>	cCSAus B300 (same polarity)

### Notes

The degree of protection (IP code) specified applies solely to a property closed cover and the use of an equivalent cable gland with adequate cable.