

Accessories - ASI
 Miniature coupler module

Description **ASI KOPPELMOD 1M M12W**

Article number **6073900088**

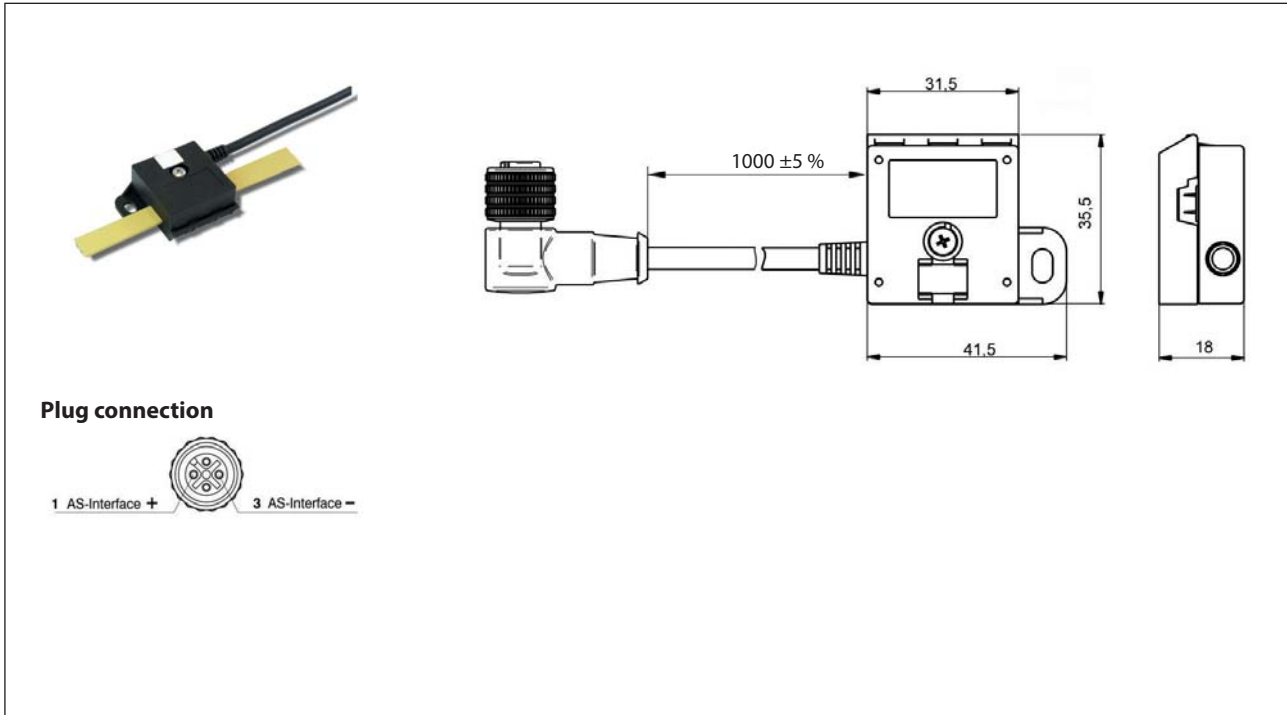

Electrical data

Operating voltage	≤ 40 V
Operating current	≤ 4 A

Mechanical data

Housing	PA 6-GF-FR/TPU
Conductor type	AS-Interface® ribbon cable
Number of connectable	1
Litz wire cross-section	1,5 mm ²
Connection	Penetration technology / screws
Connection of sensors / actuators	Circular connector M12; socket
Material conductor (outer jacket)	PUR
Conductor cross section	0,34 mm ²
User connection	acc. to IEC 947-5-2
Protection class	IP67 acc. to DIN 40050
Degree of siling	3 acc. to DIN EN 0110
Ambient temperature	-25 °C bis +70 °C
Storage temperature	-40 °C bis +80 °C
Shock stress	30 g / 11 ms
Vibration stress	10 ... 55 Hz; 1,00 mm amplitude
Weight	≈ 20 g