

Series SLK – with separate actuator

Description **SLK-MVTU24-230MC-55**

Article number **6018119004**

Position monitoring
of guard locking

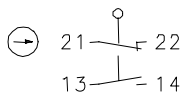

Termination electromagnet
with contact position

E1, E2 without current

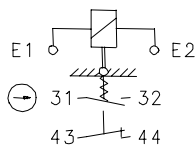

E1, E2 with current

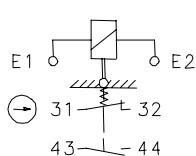

Operating diagram

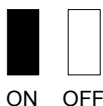
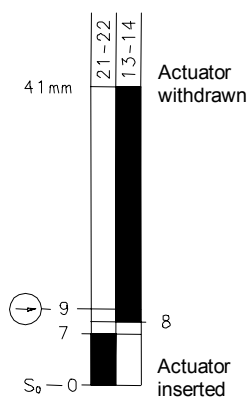

Tolerances
Actuating force: $\pm 15\%$

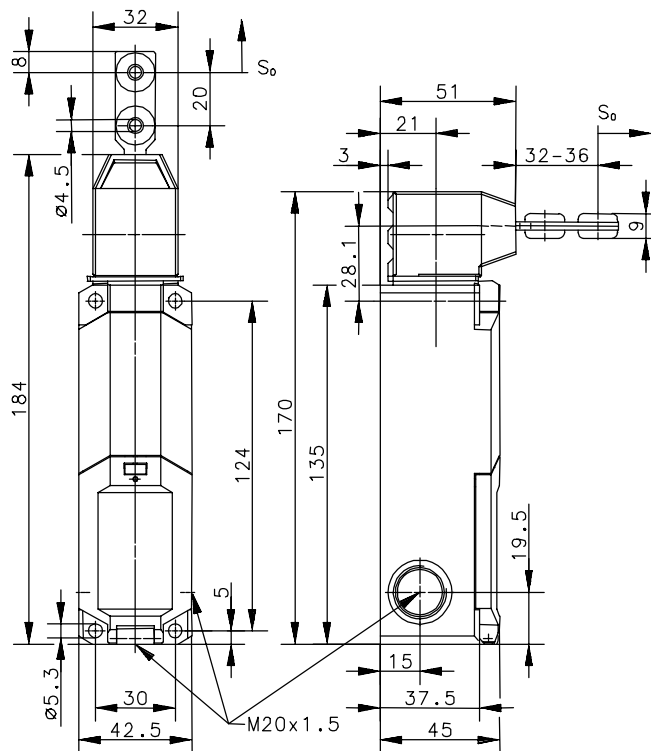

Electrical data

Protection class II, totally insulated

Contact elements

Rated insulation voltage U_i 250V

Conv. thermal current I_{the} 2,5A

Utilization category AC-15, U_e/I_e 230V/2,5A

Direct opening action \ominus according to IEC/EN 60947-5-1, Annex K

Short-circuit protective device 4A gL

Electro magnets

Duty cycle 100% ED (at E1; E2)

Temperature class B (130°C)

Inrush power consumption 56VA (0,2s)

Permanent power consumption 1,1VA

Switch operations permanent 600/h

Operating voltage 24V DC; 24, 110, 230V AC

This document will not become the contractual basis; the details included herein do not constitute any descriptions of expected conditions, so that warranties/claims for defects on account of possible variations of the actual qualities from the qualities described herein are explicitly excluded. All rights reserved. Specifications subject to change without notice!

Mechanical data			
Enclosure			Thermoplastic GV (UL94-V0)
Cover			Thermoplastic GV (UL94-V0)
Actuating head			Thermoplastic GV / Zn-GD
Actuator			Separate actuator (St / PA)
	Minimum actuating radius	R_{min}	400mm
	Velocity for actuating	V_{max}	0,5 ^m / _s
	Extraction force		≥ 27N
Interlocking principle			Magnetic force
Unlocking			Spring force
Hold on force			≤ 1500N acc. to GS-ET-19
	F_{Zh}		
Ambient air temperature			-25°C ... +70°C
Contact type			2 NC, 2 NO
Switching principle			4 slow make and break contact elements
Mechanical life			1 x 10 ⁶ switching cycles (at max. 600 switch operations / h)
Assembly			4 x M5
Connection			Cage tension spring
Conductor cross-sections			≤ 1,5mm ² flexible
Cable entrance			3 x M20x1,5
Weight			≈ 0,30kg
Installation position			Operator definable
Protection type			IP67 acc. to IEC/EN 60529

Actuation	
4 different actuating directions achievable by rotating the actuating head. Changing between horizontal and vertical actuating direction by setting the actuating head in the requested direction.	
Standards	VDE 0660 T100, DIN EN 60947-1, IEC 60947-1 VDE 0660 T200, DIN EN 60947-5-1, IEC 60947-5-1 GS-ET-19

EU Conformity	CE

Approvals	
	BG cCSA _{US} B300 (same polarity)

Notes

The degree of protection (IP code) specified applies solely to a property closed cover and the use of an equivalent cable gland with adequate cable.
The switch may not be used as a mechanical stop.
In case that power is removed from the solenoid the safety switch will be no longer in a locked position. Operator can open the guard! Attention has to be given to the risks of the machine in this situation.