

Safety switch

Series SKT- with separate actuator

Description **SKT-SA2Z M3**

Article number **6016469067**

Operating symbol

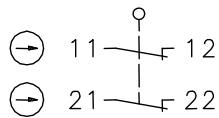

Operating diagram

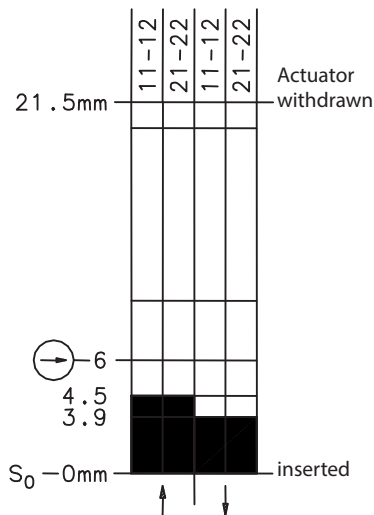

On
 Off
 Tolerance:
 Operating Point $\pm 0,25$ mm;
 Operating force ± 10 %

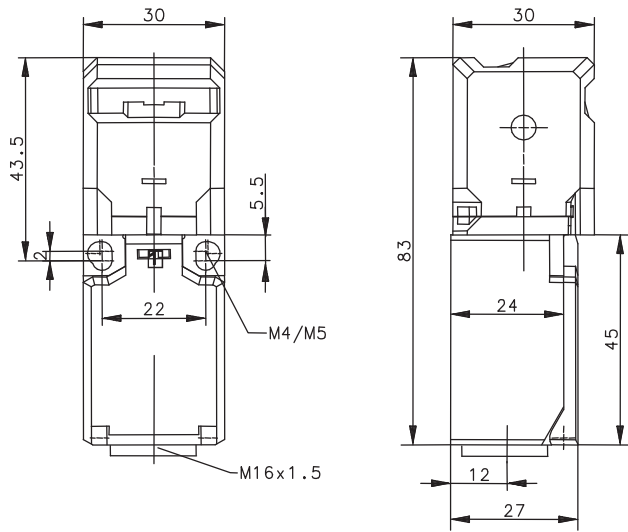

Fixed positioning for safety applications
 Mounting screw according to DIN 912 M5

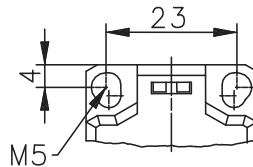

Actuator M3

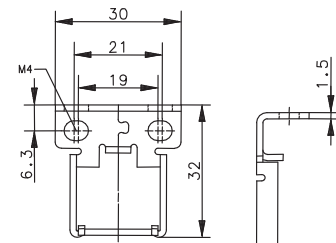

To prevent manipulation of the actuator, The unclosed safety screw must be used (M4x8)

Radial actuation / dimensions

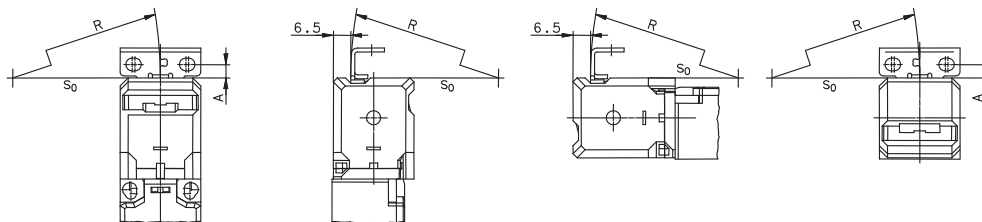

$5\text{mm} \leq A \leq 8\text{mm}$, $R \geq 150\text{mm}$
 The min. radius refers to a pivot at the top of the cap (S_0)

Electrical Data		
Rated insulation voltage	U_i	250 V
Conv. thermal current	I_{the}	10 A
Rated operational voltage	U_e	240 V AC; 250 V DC
Utilization category		AC-15, U_e / I_e 240 V / 3 A; DC-13, U_e / I_e 250 V / 0,27 A
Direct opening action	\ominus	according to IEC/EN 60947-5-1, Annex K
Short-circuit protective device		Fuse 6 A gG
Protection class		II, totally insulated

Mechanical data		
Enclosure		PBT
Cover		PA 6.6
Actuator		Separate actuator (St-stainless steel)
Extraction force		12 N
Ambient air temperature		-30 °C ... +80 °C
Contact type		2 NC (Zb)
Mechanical life		1 x 10 ⁶ switch operations
Switching frequency		≤ 30 / min.
Assembly	Safety switch	2 x M4 or M5
	Actuator	2 x M4 (supplied)
Connection		screw connections (M3,5)
Conductor cross-sections		Solid: 0,5 ... 1,5 mm ² Litz wire with ferrules: 0,5 ... 1,5 mm ²
Cable entrance		1 x M16 x 1,5
Weight		≈ 0,09 kg
Protection type		IP65 acc. to IEC/EN 60529

ID for safety engineering	
B10d	2 x 10 ⁶ switching cycles

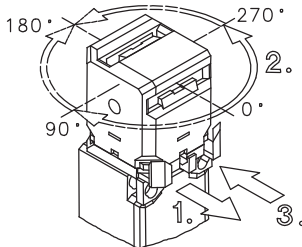
Actuation	
<ol style="list-style-type: none"> draw clasp out turn actuator head (4 x 90° rotation) press-on clasp 	

Standards	
	VDE 0660 T100, DIN EN 60947-1, IEC 60947-1
	VDE 0660 T200, DIN EN 60947-5-1, IEC 60947-5-1
	DIN EN ISO 13849-1

EU Conformity	
	acc. to directive 2006/42/EC

Approvals	
	TÜV Rheinland, Product Safety
	CCC
cCSA _{US}	A300, Q300 (same polarity)

Notes
Radial actuation may reduce the mechanical life. Unused actuator entry slot must be covered by the plug. The switch may not be used as a mechanical stop. The degree of protection (IP code) specified applies solely to a properly closed cover and the use of an equivalent cable gland with adequate cable.