

Plastic bodied limit switch
Series C74

Description **C74-EB-U1Z (SW)**

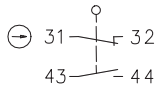

Article number **6006101108**

Operating symbol

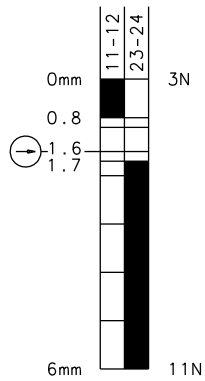

Operating diagram



 On
  Off
 Tolerance:
 Operating point $\pm 0,25$ mm;
 Operating force ± 10 %

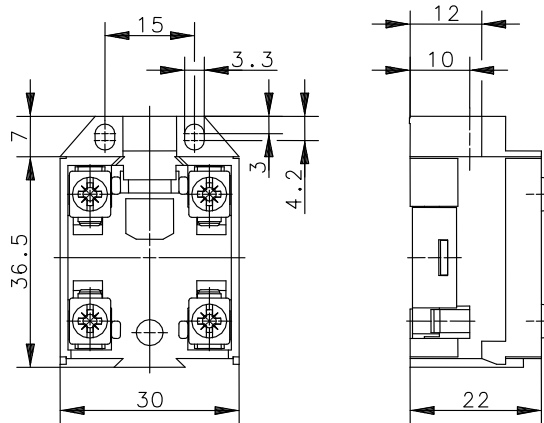

Electrical Data

Rated insulation voltage	U_i	400 V AC
Conv. thermal current	I_{the}	10 A
Rated operational voltage	U_e	240 V
Utilization category		AC-15, U_e/I_e 240 V / 3 A
Direct opening action		acc. IEC/EN 60947-5-1, annex K
Short-circuit protective device		Fuse 10 A gG

Mechanical data	
Enclosure	Thermoplastic, glass fibre reinforced (UL 94-V0)
Actuator	Plunger inside located, Ø8
Ambient air temperature	-30 °C ... +80 °C
Contact type	1 N.C., 1 N.O. (Zb)
Mechanical life	10 x 10 ⁶ operating cycles
Switching frequency	≤ 100 / min.
Assembly	2 x M3
Connection	4 screw connections (M3,5)
Conductor cross-sections	Solid: 0,5 ... 1,5 mm ² or Litz wire with ferrules: 0,5 ... 1,5 mm ²
Weight	≈ 0,03 kg
Installation position	operator definable
Protection type	IP00 nach EN 60529

Actuation	
The push bolt actuator is mainly intended to be actuated along its axis.	

ID for safety engineering	
B10d	20 x 10 ⁶ cycles

Standards	
	VDE 0660 T100, DIN EN 60947-1, IEC 60947-1
	VDE 0660 T200, DIN EN 60947-5-1, IEC 60947-5-1
	DIN EN ISO 13849-1

EU Conformity	
	acc. to directive 2014/35/EU

Approvals	
	CCC

Notes	
Because of the open construction of the device there is no special protection against ingessing of water and touching parts under voltage.	