

Actuator Series P

Description **P0-BET.**

Article number **3911462082**

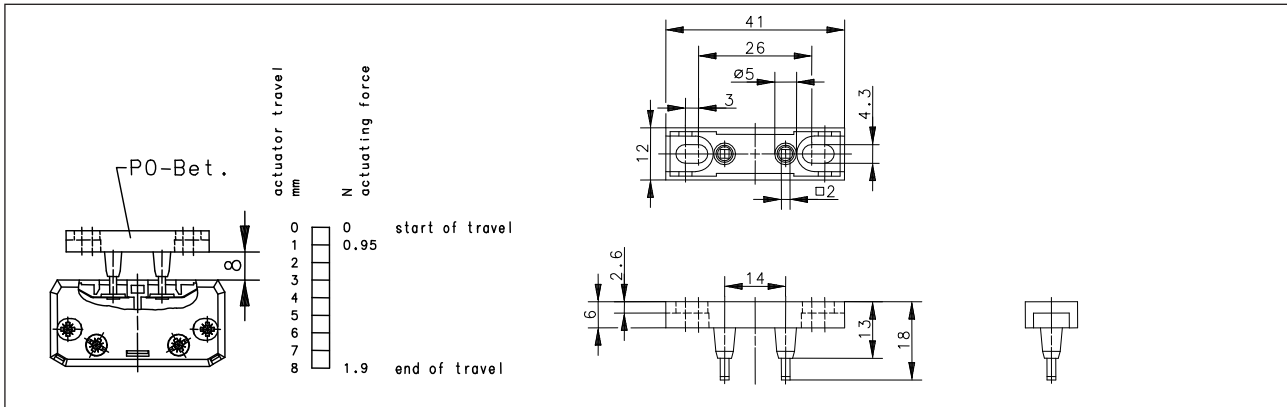

Mechanical data

Enclosure	PA 6.6 (UL 94-V0) black
Ambient air temperature	-30 °C ... +70 °C
Contact material	AgCu3 on CuNi18Zn20
Assembly	2 x M4
Weight	≈ 0,01 kg

Notes

Do not use actuator as end stop.
Only use with Bernstein safety switch serie SEL ... P.