

Technical Data

Plugs

Series AN-KAB.SHS3

Description **AN-KAB.SHS3 4P 5M WINKEL**

Article number **3251004314**

Terminal code

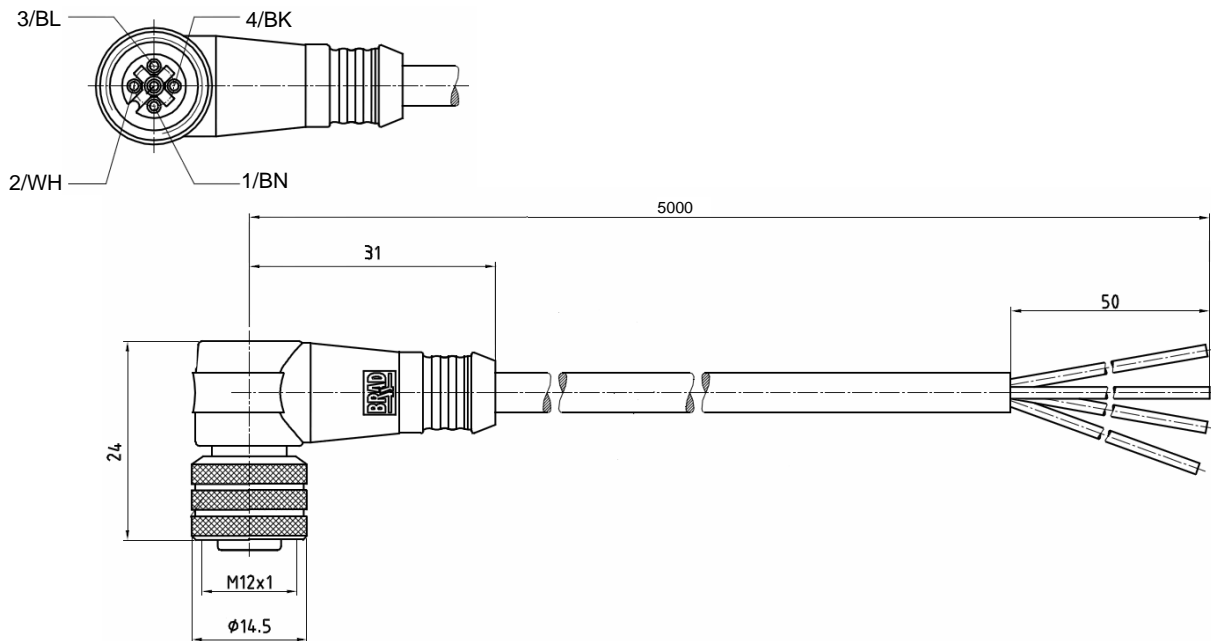

Electrical data

Nominal voltage	250 V AC
Rated current	4 A

Mechanical Data

Number of contacts	4
Degree of protection	IP68
Temperature range	-5 °C ... +105 °C (for flexing applications) -25 °C ... +105 °C (for fixed installation)
Materials	Internal pin body Moulded cable Cable wire – isolation outer jacket
	Elastollan R3000 APEX 7500-85 4 x 0,34 mm ² PVC heat-resisting UL 1731/ UL 2517, black

This document will not become the contractual basis; the details included herein do not constitute any descriptions of expected conditions, so that warranties/claims for defects on account of possible variations of the actual qualities from the qualities described herein are explicitly excluded. All rights reserved. Specifications subject to change without notice!

Date of issue : 17.04.2013 / Page 1 of 1
Document : 3251004314_en / Last update : 1 / 2207-10