

REVISIONS FOR DWG # 71-256.0A12

REV	CH.NO.	DESCRIPTION	DATE	REVISED BY
-	-	ORIGINAL DESIGN	07/15/15	ARON G

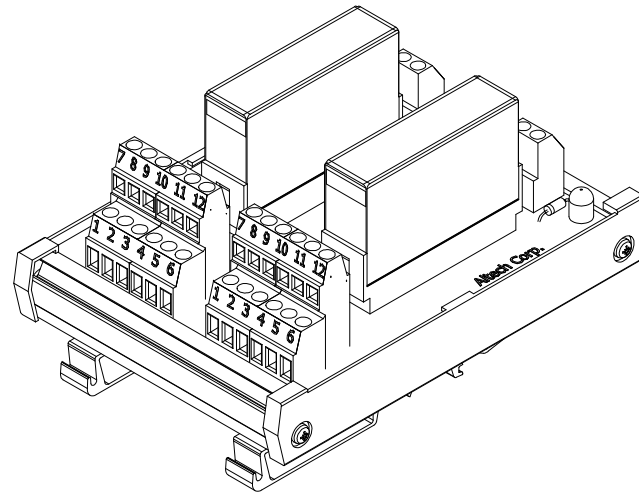

Interactive 3D Model

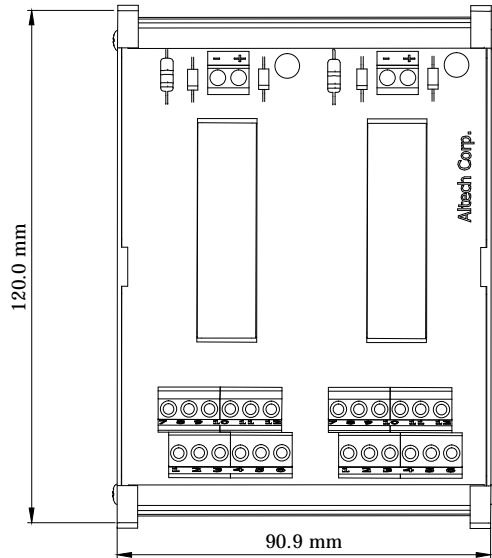
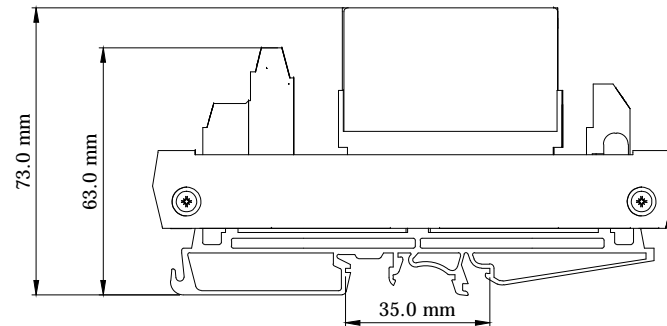
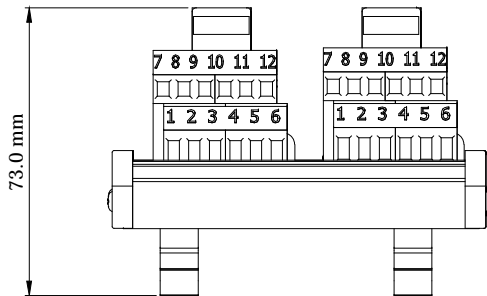

UNLESS OTHERWISE SPECIFIED
 • ALL DIMENSIONS ARE IN MILLIMETERS
 • THIRD ANGLE PROJECTION

• TOLERANCE	
XX	1.00 mm
XX.X	0.50 mm
XX.XX	0.20 mm
ALL	XX mm

C-RTM

This Drawing is the property of

Altech Corp.

35 Royal Road
 Flemington NJ 08822-6000
 (908) 806-9400 • Fax (908) 806-9490

AND IS A CONFIDENTIAL DISCLOSURE
 LENT WITHOUT CONSIDERATION OTHER
 THAN THE BORROWER'S AGREEMENT
 THAT IT SHALL NOT BE REPRODUCED,
 COPIED, LENT, OR DISPOSED OF
 DIRECTLY OR INDIRECTLY NOR USED
 FOR ANY PURPOSE OTHER THAN THAT
 FOR WHICH IT IS SPECIFICALLY
 FURNISHED.

TITLE: Safety Relay Module 6 Pole 8 Amp
 2 Channel; PN:256.0A12 [Type]

DRAWN BY: Aron Gyorgypal	07/15/15	DRAWING NO.:	M-Cad-71-256.0A12	REV.:	-
CHECKED BY: Laszlo G	07/15/15	SCALE:	-	SHEET: 1	OF: 1
RELEASED BY: Laszlo G	07/15/15				