

REVISIONS FOR DWG # 71-PIR2

REV	CH.NO.	DESCRIPTION	DATE	REVISED BY
-	-	ORIGINAL DESIGN	07/22/15	ARON G

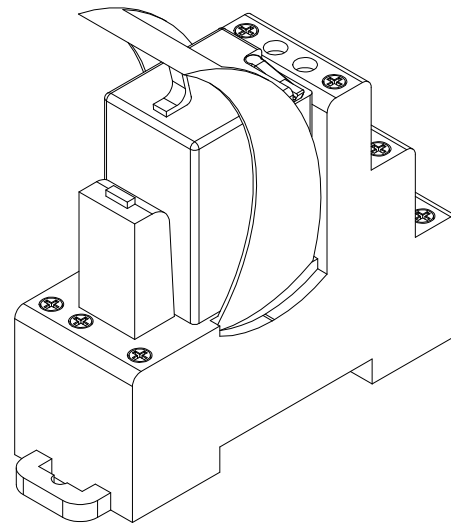
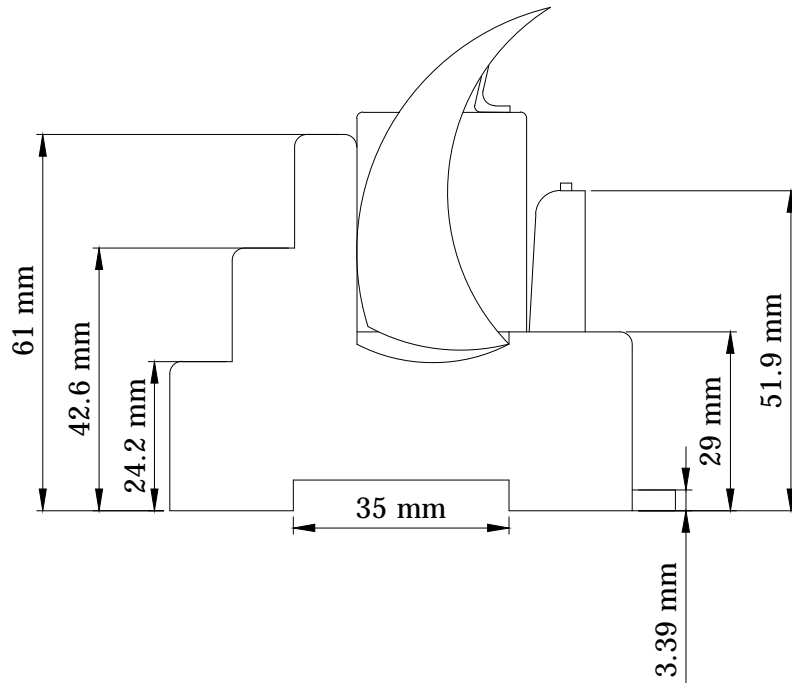
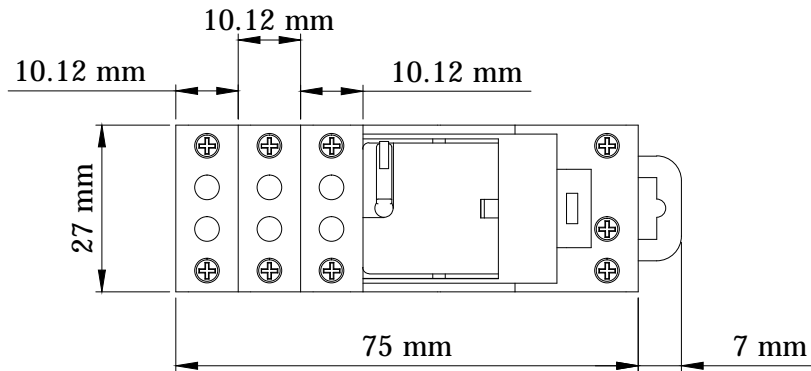

Interactive 3D Model

UNLESS OTHERWISE SPECIFIED
 • ALL DIMENSIONS ARE IN MILLIMETERS
 • THIRD ANGLE PROJECTION

• TOLERANCE	
XX	1.00mm
XX.X	0.50 mm
XX.XX	0.20 mm
ALL	XXmm

C-THINK

This Drawing is the property of

Altrech Corp.

35 Royal Road
 Flemington NJ 08822-6000
 (908) 806-9400 • Fax (908) 806-9490

AND IS A CONFIDENTIAL DISCLOSURE LENT WITHOUT CONSIDERATION OTHER THAN THE BORROWER'S AGREEMENT THAT IT SHALL NOT BE REPRODUCED, COPIED, LENT, OR DISPOSED OF DIRECTLY OR INDIRECTLY NOR USED FOR ANY PURPOSE OTHER THAN THAT FOR WHICH IT IS SPECIFICALLY FURNISHED.

TITLE: Relay Socket Combination
 PIR2 [Type]

DRAWN BY: Aron Gyorgypal	07/22/15	DRAWING NO.:	M-Cad-71-PIR2	REV.:	-
CHECKED BY: Laszlo G	07/22/15	SCALE:	-	SHEET:	1 OF: 1
RELEASED BY: Laszlo G	07/22/15				