

REVISIONS FOR DWG # CGT4N

REV	CH.NO.	DESCRIPTION	DATE	REVISED BY
-	-	ORIGINAL DESIGN	07/29/16	ARON G

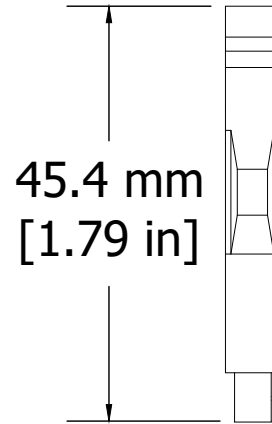
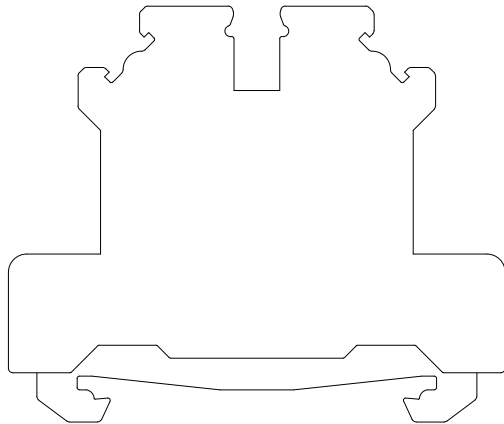
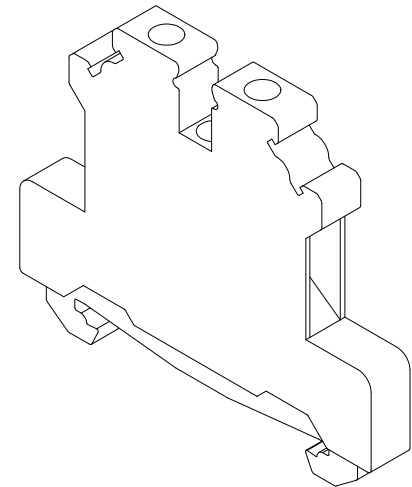
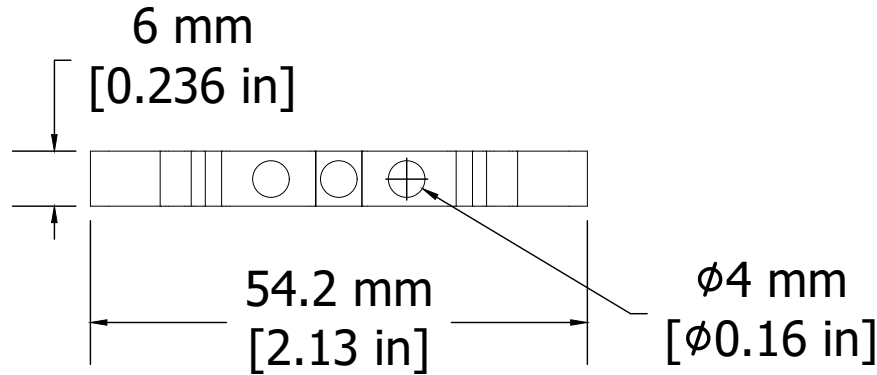

UNLESS OTHERWISE SPECIFIED
 • ALL DIMENSIONS ARE IN MILLIMETERS
 • THIRD ANGLE PROJECTION

• TOLERANCE

XX	∅	1.00 mm
XX.X	∅	0.50 mm
XX.XX	∅	0.20 mm
ALL	∅	XX mm

C-RTM

This Drawing is the property of

Altrech Corp.

35 Royal Road
 Flemington NJ 08822-6000
 (908) 806-9400 • Fax (908) 806-9490

AND IS A CONFIDENTIAL DISCLOSURE
 LENT WITHOUT CONSIDERATION OTHER
 THAN THE BORROWER'S AGREEMENT
 THAT IT SHALL NOT BE REPRODUCED,
 COPIED, LENT, OR DISPOSED OF
 DIRECTLY OR INDIRECTLY NOR USED
 FOR ANY PURPOSE OTHER THAN THAT
 FOR WHICH IT IS SPECIFICALLY
 FURNISHED.

TITLE: Ground Blocks, Terminal Block
 PN: CGT4N

DRAWN BY: Aron Gyorgypal	07/29/16	DRAWING NO.:	M-Cad-2dr-CGT4N	REV.:	-
CHECKED BY: Markus K	07/29/16	SCALE:	-	SHEET: 1	OF: 1
RELEASED BY: Laszlo G	07/29/16				